

CATALOGUE

DENTAL INSTRUMENTS



Tooth Extracting Forceps(eng)



Incisors And Cuspids 1

HD-51-001

Tooth Ext Forceps
Fig- 1

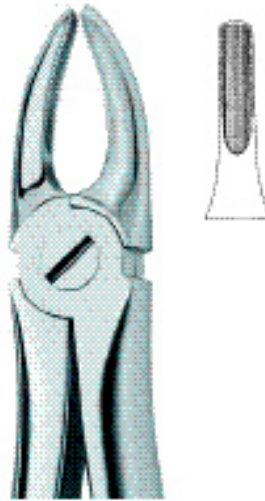

Incisors And Bicuspid 2

HD-51-002

Tooth Ext Forceps
Fig. 2



Lower Incisors And Canines 4

HD-51-004

Tooth Ext Forceps
Fig. 4

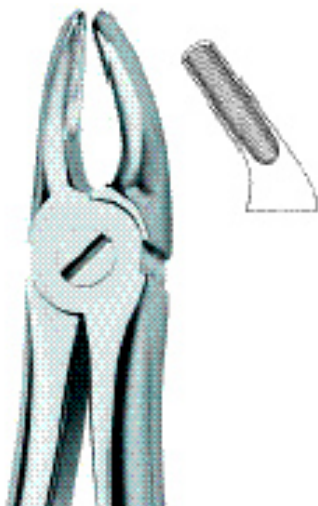

Bicuspid 7

HD-51-007

Tooth Ext Forceps
Fig. 7



Lower Bicuspid, Universal 13

HD-51-013

Tooth Ext Forceps
Fig. 13

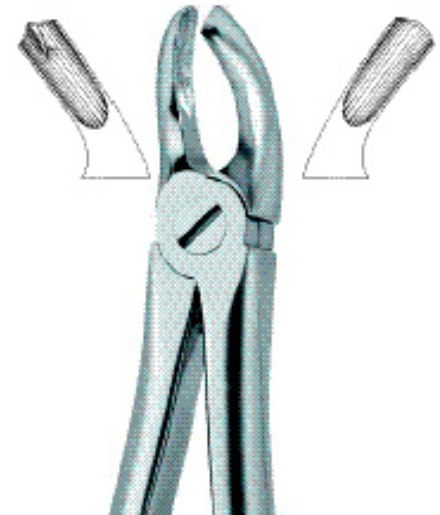

Molars, Right 17

HD-51-017

Tooth Ext Forceps
Fig- 17

Tooth Extracting Forceps(eng)

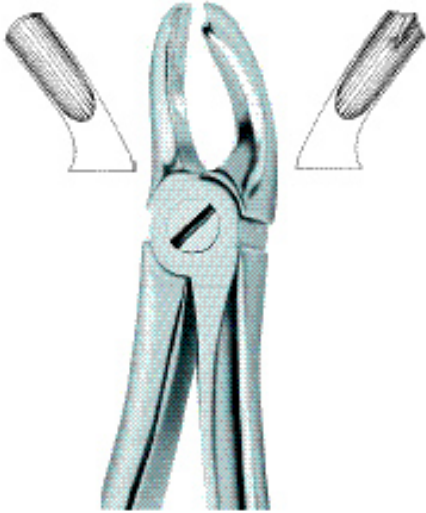

Molars, Left 18

HD-51-018

Tooth Ext Forceps
Fig. 18

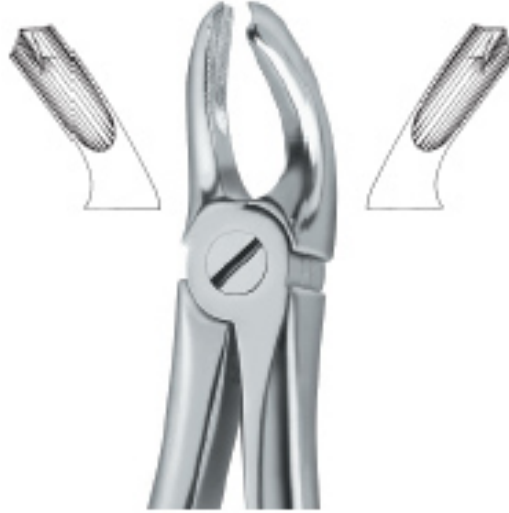

Molars 18A

HD-51-018-01

Tooth Ext Forceps
Fig. 18A



Lower Molars , Universal 22

HD-51-022

Tooth Ext Forceps
Fig. 22



Lower Molars, Right 23

HD-51-023

Tooth Ext Forceps
Fig. 23



Lower Molars, Left 24

HD-51-024

Tooth Ext Forceps
Fig. 24



Upper Roots And Incisors 29

HD-51-029

Tooth Ext Forceps
Fig. 29

Tooth Extracting Forceps(eng)



Lower Roots 33

HD-51-033

Tooth Ext Forceps



Lower Roots 01

HD-51-033-01

Tooth Ext Forceps



Lower Roots 03

HD-51-033-03

Tooth Ext Forceps



Lower Roots 06

HD-51-033-06

Tooth Ext Forceps

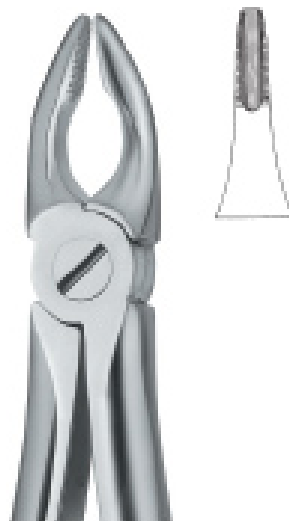

Incisors And Bicuspid 34N

HD-51-034

Tooth Ext Forceps

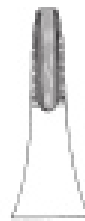

Incisors And Bicuspid 35N

HD-51-035

Tooth Ext Forceps

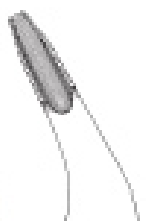

Tooth Extracting Forceps(eng)



HD-51-036

Tooth Ext Forceps



Lower Roots 46

HD-51-046

Tooth Ext Forceps



Lower Roots 46

HD-51-046-01

Tooth Ext Forceps



Lower Roots 46

HD-51-046-02

Tooth Ext Forceps



Very Fine Roots 49

HD-51-049

Tooth Ext Forceps



Roots 51

HD-51-051

Tooth Ext Forceps

Tooth Extracting Forceps(eng)



Roots 51A

HD-51-051-01

Tooth Ext Forceps



Roots 51 C

HD-51-051-03

Tooth Ext Forceps



HD-51-057

Tooth Ext Forceps



HD-51-057-1

Tooth Ext Forceps



HD-51-057-02

Tooth Ext Forceps



Third Molars 67

HD-51-067

Tooth Ext Forceps

Tooth Extracting Forceps(eng)



Third Molars 67 A

HD-51-067-01

Tooth Ext Forceps



Third Molars Deep Griping 67 N

HD-51-067-02

Tooth Ext Forceps



Lower Molars 73

HD-51-073

Tooth Ext Forceps



Lower Roots 74

HD-51-074

Tooth Ext Forceps



Incisors And Roots 74N

HD-51-074-06

Tooth Ext Forceps



Incisors And Roots ,Slender Jaw74XN

HD-51-074-07

Tooth Ext Forceps

Tooth Extracting Forceps(eng)



Incisors And Bicuspids

HD-51-075

Tooth Ext Forceps



Upper Roots 76

HD-51-076

Tooth Ext Forceps



Upper Roots 76N

HD-51-076-07

Tooth Ext Forceps



Third Molars 79

HD-51-079

Tooth Ext Forceps



Third Molars 79A

HD-51-079-01

Tooth Ext Forceps

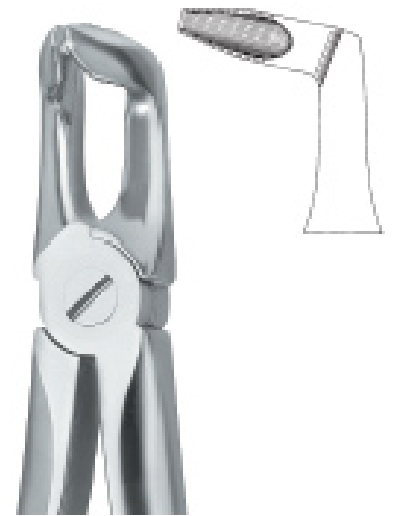

Third Molars ,Deep Gripping 79N

HD-51-079-02

Tooth Ext Forceps

Tooth Extracting Forceps(eng)



**Molars With Carious Or Broken Caps
86A**

HD-51-086-01

Tooth Ext Forceps



**Molars With Carious Or Broken Caps
86B**

HD-51-086-02

Tooth Ext Forceps



**Molars With Carious Or Broken Caps
86C**

HD-51-086-03

Tooth Ext Forceps



HD-51-097

Tooth Ext Forceps



Very Fine Roots 133

HD-51-133

Tooth Ext Forceps



Roots Fragments, Deep Gripping 146

HD-51-146

Tooth Ext Forceps

Tooth Extracting Forceps(eng)



Tooth Ext Forceps

HD-51-151

Tooth Ext Forceps



Tooth Ext Forceps

HD-51-153



Roots, With Parallel Beak 233

HD-51-233

Tooth Ext Forceps



Incisors And Bicuspid 1

HD-51-301

Tooth Ext Forceps



Incisors And Bicuspid 2

HD-51-302

Tooth Ext Forceps



Bicuspid 7

HD-51-307

Tooth Ext Forceps

Tooth Extracting Forceps(eng)



Bicuspid 13

HD-51-313

Tooth Ext Forceps

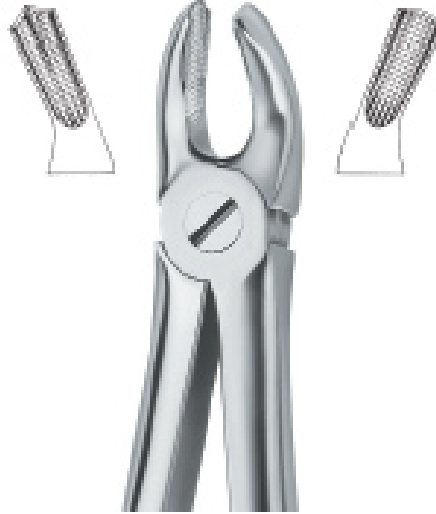

Molars 17

HD-51-317

Tooth Ext Forceps



Molars 18

HD-51-318

Tooth Ext Forceps



Molars 22

HD-51-322

Tooth Ext Forceps



Roots 33

HD-51-330

Tooth Ext Forceps



Roots 33

HD-51-333

Tooth Ext Forceps

Tooth Extracting Forceps(eng)

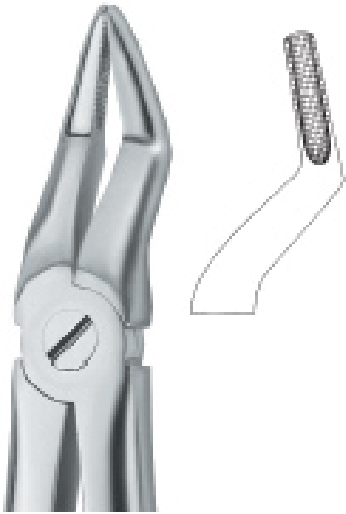

Roots 51

HD-51-351

Tooth Ext Forceps



Roots, Very Fine Beak 51A

HD-51-351-01

Tooth Ext Forceps



Third Molars 67 A

HD-51-367-01

Tooth Ext Forceps



Molars 73

HD-51-373

Tooth Ext Forceps



Incisors And Roots 74

HD-51-374

Tooth Ext Forceps



**Incisors And Roots , With Fine Beak
74N**

HD-51-374-01

Tooth Ext Forceps

Tooth Extracting Forceps(eng)

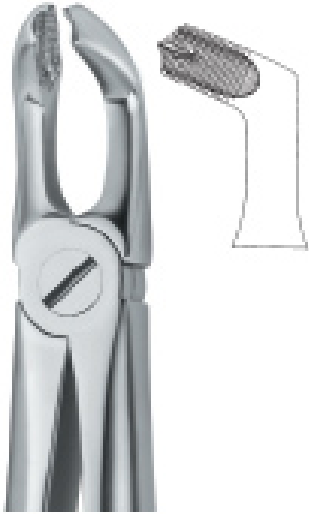

Third Molars 79

HD-51-379

Tooth Ext Forceps



Incisors And Cuspids 1

HD-51-401

Tooth Ext Forceps



Bicuspid 7

HD-51-407

Tooth Ext Forceps



Incisors And Cuspids 13

HD-51-413

Tooth Ext Forceps



Molars , Right 17

HD-51-417

Tooth Ext Forceps



Molars , Left 18

HD-51-418

Tooth Ext Forceps

Tooth Extracting Forceps(eng)



Molars 22

HD-51-422

Tooth Ext Forceps



Roots 33

HD-51-433

Tooth Ext Forceps



Very Fine Roots 46

HD-51-446

Tooth Ext Forceps

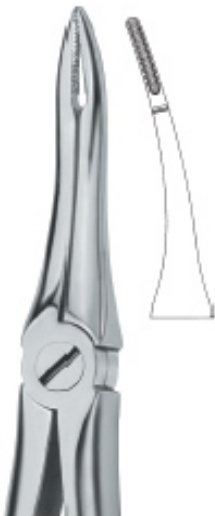

Very Fine Roots 49

HD-51-449

Tooth Ext Forceps



Roots 51

HD-51-451

Tooth Ext Forceps



Roots , With Fine Beak 51A

HD-51-451-01

Tooth Ext Forceps

Tooth Extracting Forceps(eng)



Martin Ergo 67A

HD-51-467-01

Tooth Ext Forceps



Martin Ergo 74N

HD-51-474

Tooth Ext Forceps



Martin Ergo 79

HD-51-479

Tooth Ext Forceps



Martin Ergo ,Very Fine Roots 97

HD-51-497

Tooth Ext Forceps



Bicuspid 13S

HD-51-613-09

Tooth Ext Forceps



Molars 22s

HD-51-622-09

Tooth Ext Forceps

Tooth Extracting Forceps(eng)



Incisors And Roots 30S

HD-51-630-09

Tooth Ext Forceps



Roots 33S

HD-51-633-09

Tooth Ext Forceps



Incisors And Bicuspid 37

HD-51-637

Tooth Ext Forceps



Incisors And Cuspid 38

HD-51-638

Tooth Ext Forceps



Molars 39

HD-51-639

Tooth Ext Forceps



Molars 39A

HD-51-639-01

Tooth Ext Forceps

Tooth Extracting Forceps(eng)



Molars , Left 39L

HD-51-639-05

Tooth Ext Forceps



Molars , Right 39R

HD-51-639-08

Tooth Ext Forceps



Molars 40

HD-51-640

Tooth Ext Forceps



Roots 51S

HD-51-651-09

Tooth Ext Forceps



Roots 76S

HD-51-676-09

Tooth Ext Forceps



Molars 3

HD-51-703

Tooth Ext Forceps

Tooth Extracting Forceps(eng)



Incisors 5

HD-51-705

Tooth Ext Forceps



Molars 6

HD-51-706

Tooth Ext Forceps



Roots 7

HD-51-707

Tooth Ext Forceps



Incisors And Cuspids 137

HD-51-737

Tooth Ext Forceps



Bicuspids 139

HD-51-739

Tooth Ext Forceps



Klein , Roots 51S

HD-51-751-09

Tooth Ext Forceps

Tooth Extracting Forceps(eng)



Molars 17SK

HD-51-817-09

Tooth Ext Forceps



Molars 23SK

HD-51-823-09

Tooth Ext Forceps



**Teeth And Roots ,Universal
150SK**

HD-51-850-09

Tooth Ext Forceps



**Teeth And Roots, Universal
151Sk**

HD-51-851-09

Tooth Ext Forceps



Physic Forceps

HD-51-852-09

Physic Forceps Set Of 4 Pieces.



**UPPER ANTERIOR NOTCHED
BEAKS X-TRAC FORCEPS**

HD-51-853-09

X-Trac Upper Anterior Forceps has notches on the beaks which enable you to engage

Tooth Extracting Forceps(eng)



ROBA TOOTH ROOT EXTRACTION FORCEPS

HD-51-853-09

F16 Upper Root Forceps are designed for extracting root fragments in the upper posterior region.



ROBA LOWER ANTERIOR DENTAL EXTRACTION FORCEPS

HD-51-854-09

F4 Lower Anterior Forceps have an apical beak for extracting teeth in the lower anterior region.



ROBA UPPER ANTERIOR DENTAL EXTRACTION FORCEPS

HD-51-855-09

F1 Upper Universal Forceps for extracting teeth in the upper anterior region.



ROBA WISDOM TEETH DENTAL EXTRACTION FORCEPS

HD-51-856-09

Lower Wisdom Forcep (222AF) is designed to extract 3rd molars in the upper region.



ROBA FORCEPS LOWER NARROW

HD-51-857-09

Roba Forceps Lower Narrow Stainless Steel. Available in Satin, Polish Mirror, Titanium Coating and Gold Platted finishing.

Tooth Extracting Forceps(amr)



Incisors And Bicuspid 1

HD-52-001

Tooth Ext Forceps Amr



Henahan Incisors 1A

HD-52-001-01

Tooth Ext Forceps Amr



Molars And Third Molars 10S

HD-52-010-09

Tooth Ext Forceps Amr



Molars 15

HD-52-015

Tooth Ext Forceps Amr



Molars 16

HD-52-016

Tooth Ext Forceps Amr



Molars , Slender Jaw

HD-52-016-09

Tooth Ext Forceps Amr

Tooth Extracting Forceps(amr)



Molars 17

HD-52-017

Tooth Ext Forceps Amr



Harris Molars , Left 18L

HD-52-018-05

Tooth Ext Forceps Amr

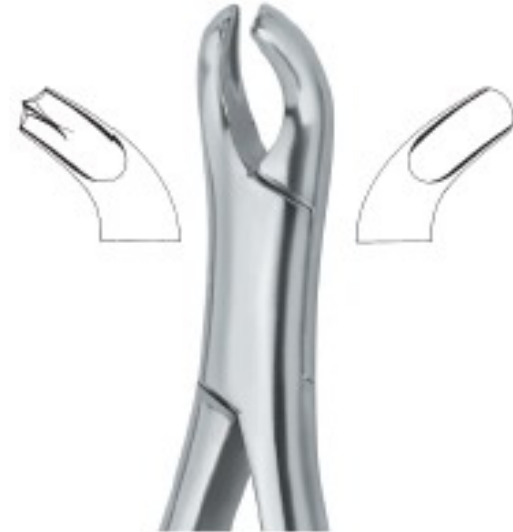

Harris Molars , Right 18R

HD-52-018-08

Tooth Ext Forceps Amr



Molars

HD-52-023

Tooth Ext Forceps Amr



Parmlly Molars And Bicuspid 32

HD-52-032

Tooth Ext Forceps Amr



**Parmlly Molars And Bicuspid , Roots
32A**

HD-52-032-01

Tooth Ext Forceps Amr

Tooth Extracting Forceps(amr)



Molars , Left 53L

HD-52-053-05

Tooth Ext Forceps Amr



Molars , Right 53R

HD-52-053-08

Tooth Ext Forceps Amr



Teeth And Roots,Universal Also For Children 62

HD-52-062

Tooth Ext Forceps Amr



Incisors And Roots 65

HD-52-065

Tooth Ext Forceps Amr



Tomes Roots Fragments And Small Roots 69

HD-52-069

Tooth Ext Forceps Amr



Nevius Molars , Left 88L

HD-52-088-05

Tooth Ext Forceps Amr

Tooth Extracting Forceps(amr)



Nevius Molars , Right 88R

HD-52-088-08

Tooth Ext Forceps Amr



**Cryer Bicuspid, Incisors And
Roots 150**

HD-52-150

Tooth Ext Forceps Amr



**Cryer Bicuspid, Incisors And
Roots 150A**

HD-52-150-01

Tooth Ext Forceps Amr



Bicuspid And Incisors , Roots 150X

HD-52-150-02

Tooth Ext Forceps Amr



**Bicuspid And Incisors, Roots
150AS**

HD-52-150-08

Tooth Ext Forceps Amr



**Cryer Bicuspid And Incisors ,
Roots 150S**

HD-52-150-09

Tooth Ext Forceps Amr

Tooth Extracting Forceps(amr)



**Cryer Bicuspid , Incisors And Roots
151**

HD-52-151

Tooth Ext Forceps Amr



**Cryer Bicuspid , Incisors And Roots
151A**

HD-52-151-01

Tooth Ext Forceps Amr



**Cryer Bicuspid , Incisors And Roots
151X**

HD-52-151-02

Tooth Ext Forceps Amr



Bicuspid And Incisors , Roots 151AS

HD-52-151-08

Tooth Ext Forceps Amr



**Cryer Teeth And Roots , Universal
151S**

HD-52-151-09

Tooth Ext Forceps Amr



Third Molars 222

HD-52-222

Tooth Ext Forceps Amr

Tooth Extracting Forceps(amr)



Root Fragments And Universal 501

HD-52-501

Tooth Ext Forceps Amr



Witzel Root Fragments And Universal 502

HD-52-502

Tooth Ext Forceps Amr

Root Elevators



Seldin 1L

HD-53-001-05

Root Elevators



Seldin 1R

HD-53-001-08

Root Elevator



Seldin 2

HD-53-002-00

Root Elevators

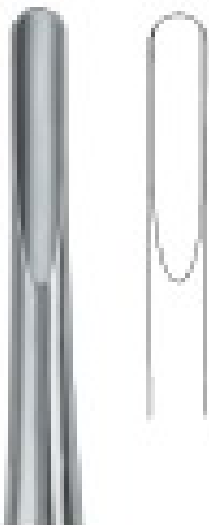

Seldin

HD-53-003-00

Root Elevators

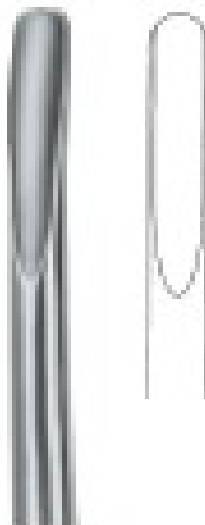

Cryer

HD-53-003-01

Root Elevators



Seldin 4L

HD-53-004-05

Root Elevators



Seldin 4R

HD-53-004-08

Root Elevators



Crane Pick 6

HD-53-006-00

Root Elevators



Miller 1

HD-53-008-00

Root Elevators

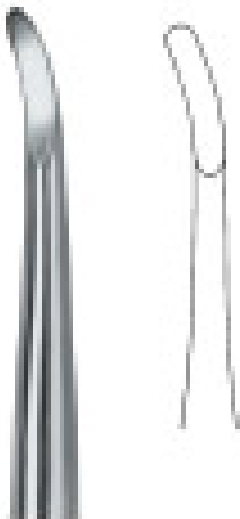

Miller 2

HD-53-009-00

Root Elevators



Miller-Apexo

HD-53-010-00

Root Elevators



Miller-Apexo

HD-53-011-00

Root Elevators

Root Elevators



Cryer
HD-53-012-00
Root Elevators



Cryer
HD-53-027-00
Root Elevators



Cryer 28
HD-53-028-00
Root Elevators



Seldin 34
HD-53-034-00
Root Elevators

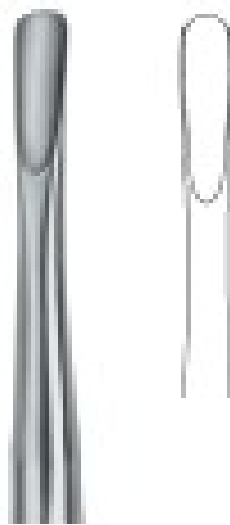

Seldin 34S
HD-53-034-09
Root Elevators



Cryer 27S
HD-53-039-00
Root Elevators



Cryer 28S

HD-53-040-00

Root Elevators

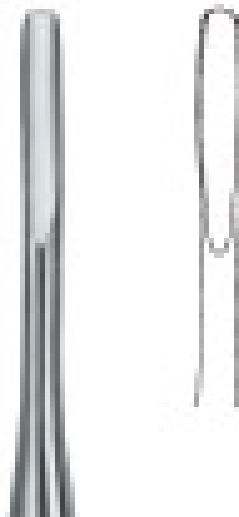

Flohr

HD-53-046-00

Root Elevators



Barry 50

HD-53-050-00

Root Elevators



Barry 51

HD-53-051-00

Root Elevators



Lindo Levian 1

HD-53-200-01

Root Elevators

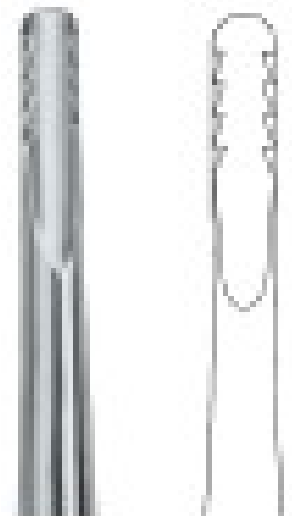

Lindo Levian 3

HD-53-200-03



Howard-Apexo # 1

HD-53-204-00

Root Elevators



HD-53-204-01

Root Elevators

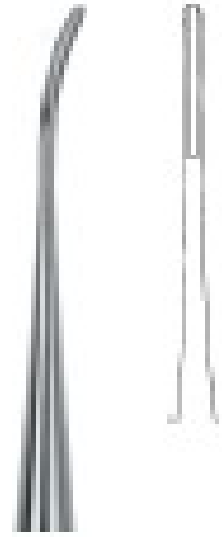

Root Elevators

HD-53-205-00

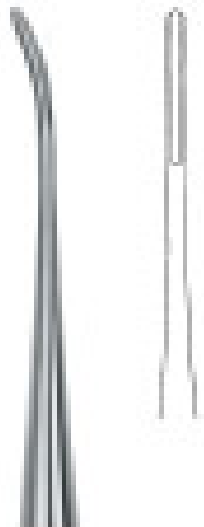

Root Elevators

HD-53-205-01



Bein S2

HD-53-220-02

Root Elevator Bein size 2.0mm

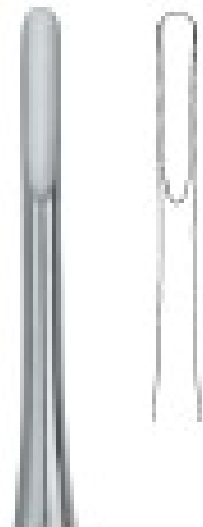

Bein S3

HD-53-220-03

Root Elevator Bein size 3.0mm

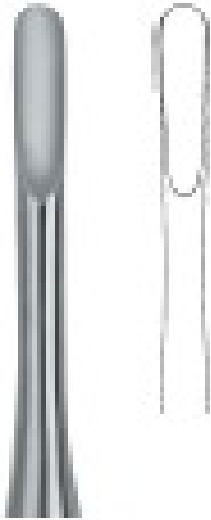

Bein S4

HD-53-220-04

Root Elevator Bein size 4.0mm

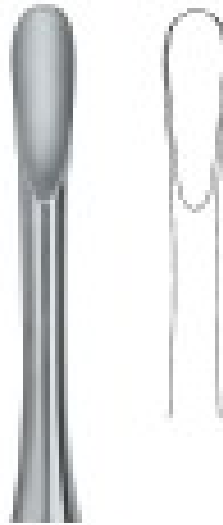

Bein S5

HD-53-220-05

Root Elevator Bein size 5.0mm

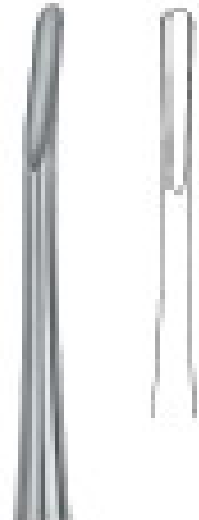

Bein 2A

HD-53-221-02

Root Elevator Bein Angled Size 2.0mm

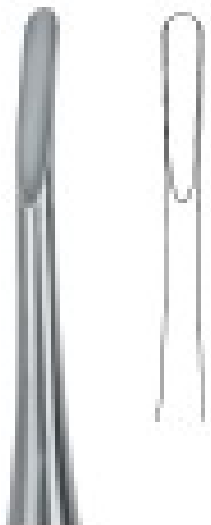

Bein 3A

HD-53-221-03

Root Elevator Bein Angled Size 3.0mm

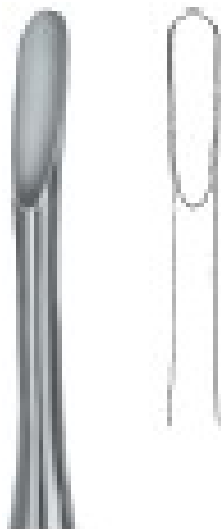

Bein 4A

HD-53-221-04

Root Elevator Bein Angled Size 4.0mm

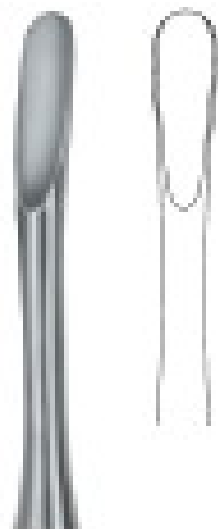

Bein 5A

HD-53-221-05

Root Elevator Bein Angled Size 5.0mm



Apical 1
HD-53-222-01

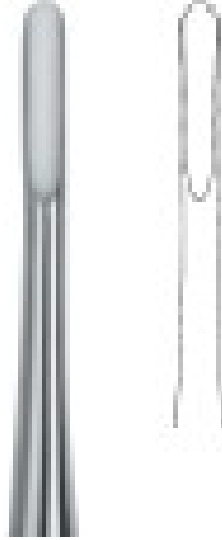

Apical 2
HD-53-222-02



Apical 3
HD-53-222-03

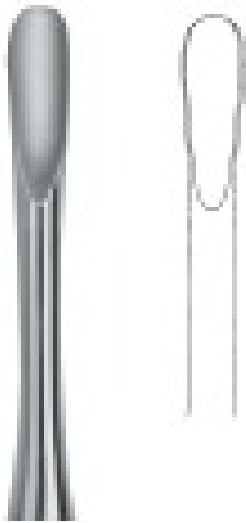

Apical 4
HD-53-222-04

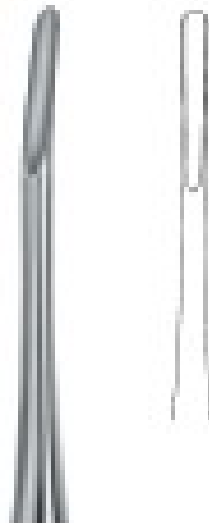

Apical 1A
HD-53-223-01



Apical 2A
HD-53-223-02

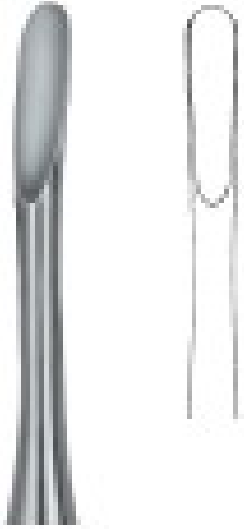

Apical 3A

HD-53-223-03

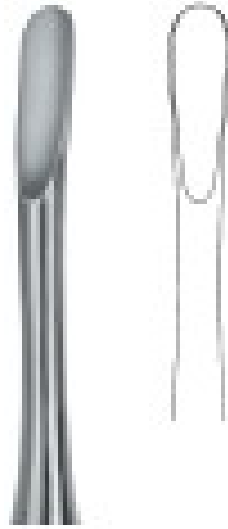

Apical 4A

HD-53-223-04



Apical 301

HD-53-301-00

Root Elevators



Apical 302

HD-53-302-00

Root Elevators



Apical-Flohr

HD-53-303-00

Root Elevators

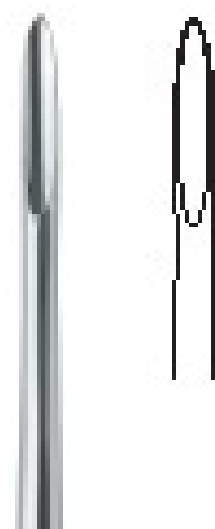

Apical 304

HD-53-304-00

Root Elevators

Root Elevators

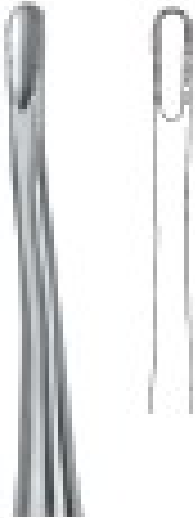

Apical 46R

HD-53-311-00

Root Elevators



Coleman

HD-53-405-01

Root Elevators



Coleman 2L

HD-53-405-02

Root Elevators



Coleman 3R

HD-53-405-03

Root Elevators

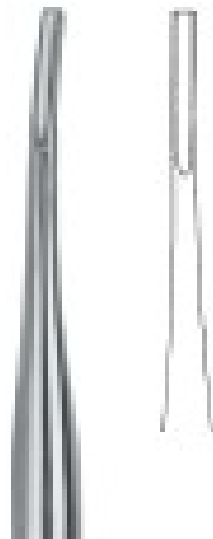

Coupland Bone Chisels 1

HD-53-415-01

Root Elevators



Coupland Bone Chisels 2

HD-53-415-02

Root Elevators

Root Elevators

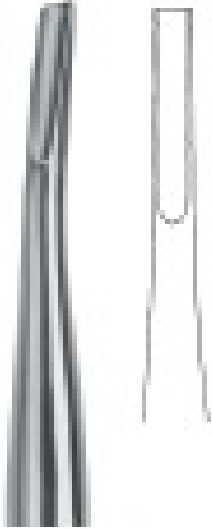

Coupland Bone Chisels 3

HD-53-415-03

Root Elevators



Friedman 1

HD-53-505-01

Root Elevators



Friedman 2L

HD-53-505-02

Root Elevators



Friedman 2R

HD-53-505-03

Root Elevators



Hylin 1

HD-53-508-01

Root Elevators

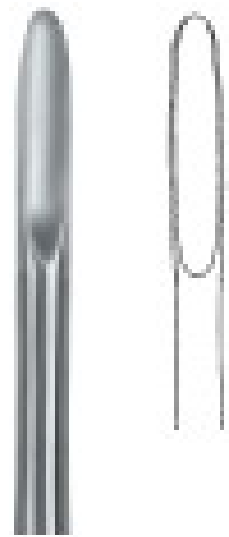

Hylin 2

HD-53-508-02

Root Elevators

Root Elevators

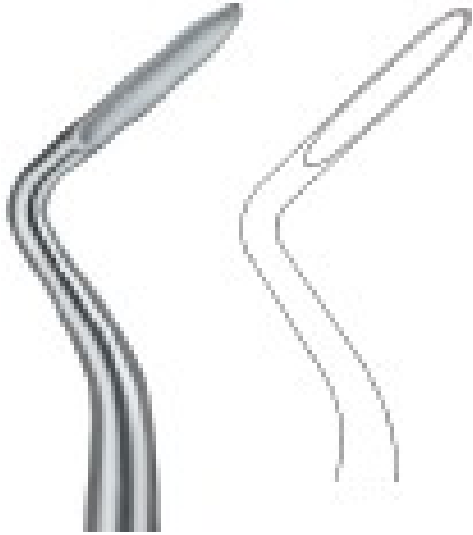

Hylin 3L

HD-53-508-03

Root Elevators



Hylin 4R

HD-53-508-04

Root Elevators



Bein 0

HD-53-511-00

Root Elevators

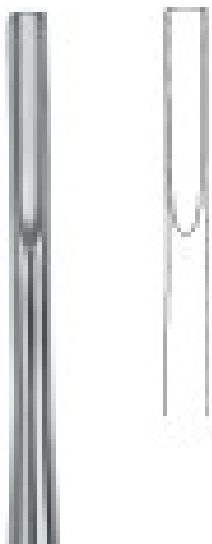

Bein 1

HD-53-511-01

Root Elevators

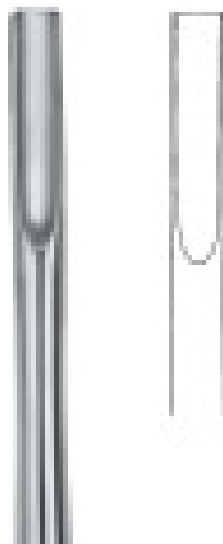

Bein 2

HD-53-511-02

Root Elevators



Bein

HD-53-512-00

Root Elevators

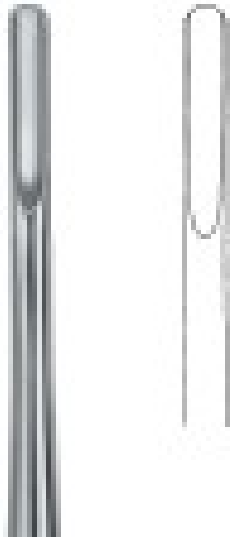

Bein 1

HD-53-512-01

Root Elevators

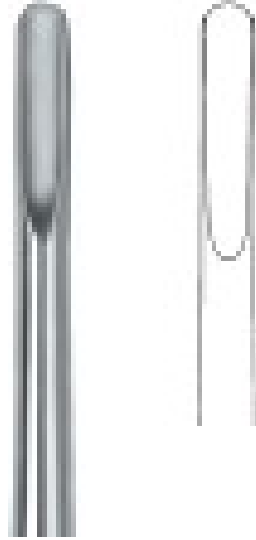

Bein 2

HD-53-512-02

Root Elevators



Bein 0

HD-53-513-00

Root Elevators

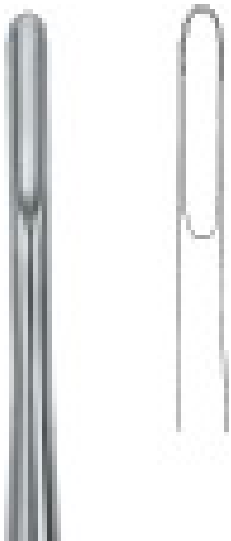

Bein 1

HD-53-513-01

Root Elevators

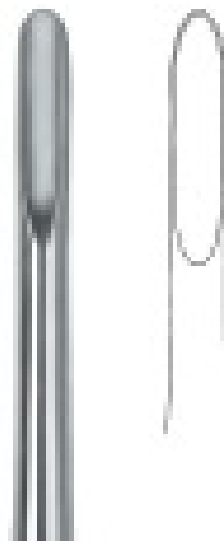

Bein 2

HD-53-513-02

Root Elevators



Bein 0A

HD-53-514-00

Root Elevators

Root Elevators

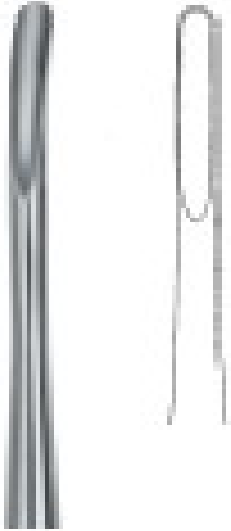

Bein 1A

HD-53-514-01

Root Elevators

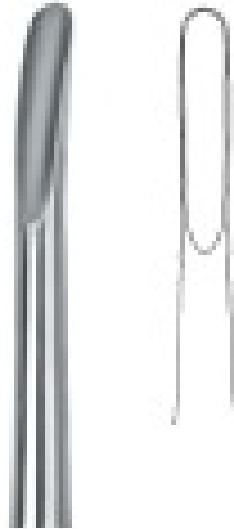

Bein 2A

HD-53-514-02

Root Elevators



Bein 0A

HD-53-515-00

Root Elevators

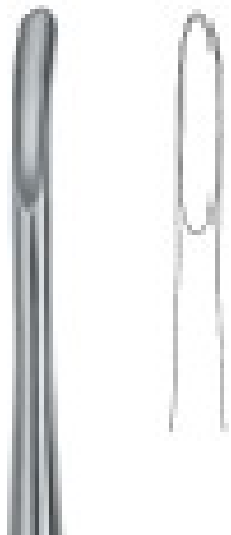

Bein 1A

HD-53-515-01

Root Elevators

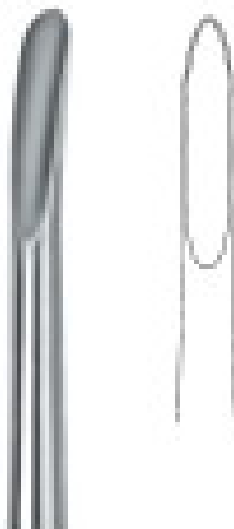

Bein 2A

HD-53-515-02

Root Elevators



W.F. Barry 320L

HD-53-533-20

Root Elevators

Root Elevators



W.F. Barry 321R

HD-53-533-21

Root Elevators



Barry 322

HD-53-533-22

Root Elevators



Barry 323

HD-53-533-23

Root Elevators



W.F. Barry 370R

HD-53-533-70

Root Elevators



W.F. Barry 371R

HD-53-533-71

Root Elevators



Winter 11L

HD-53-551-05

Root Elevators



Winter 11R

HD-53-551-08

Root Elevators



Winter 13L

HD-53-553-05

Root Elevators



Winter 13R

HD-53-553-08

Root Elevators



Winter 14L

HD-53-554-05

Root Elevators



Winter 14R

HD-53-554-08

Root Elevators

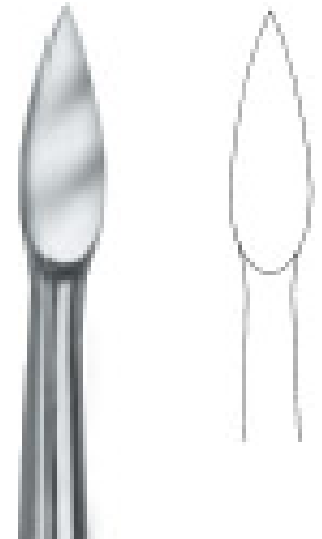

Lecluse 1

HD-53-561-01

Root Elevators



Pott 1

HD-53-567-01

Root Elevators



Pott 2

HD-53-567-02

Root Elevators



Krallenheber 1L

HD-53-571-01

Root Elevators



Krallenheber 2R

HD-53-571-02

Root Elevators



Warwick-James 1

HD-53-576-01

Root Elevators

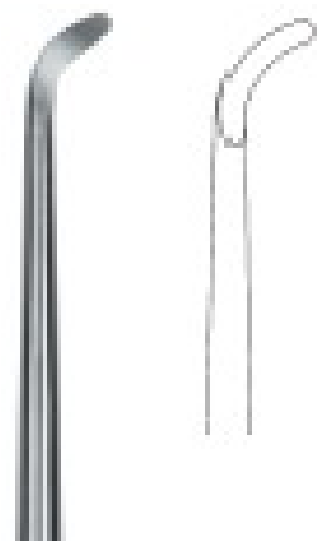

Warwick-James 2L

HD-53-576-02

Root Elevators

Root Elevators



Warwick-James 3R

[HD-53-576-03](#)

Root Elevators



Chompret 1

[HD-53-577-01](#)

Root Elevators



Chompret 2

[HD-53-577-02](#)

Root Elevators

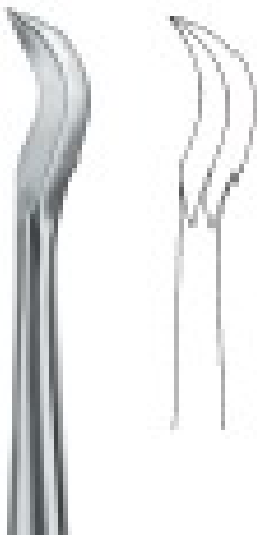

Chompret 3

[HD-53-577-03](#)

Root Elevators



Heidebrink 1

[HD-53-582-01](#)

Root Elevators



Heidebrink 2

[HD-53-582-02](#)

Root Elevators

Root Elevators



Heidebrink 3

HD-53-582-03

Root Elevators



West 1

HD-53-584-01

Root Elevators

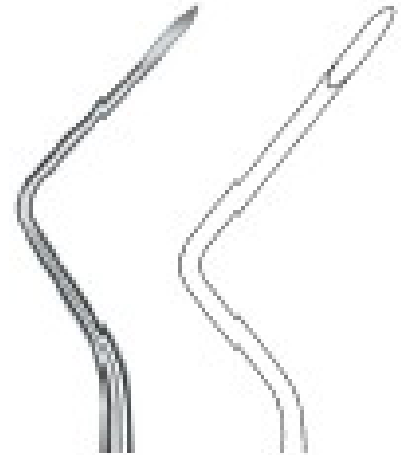

West 2

HD-53-584-02

Root Elevators

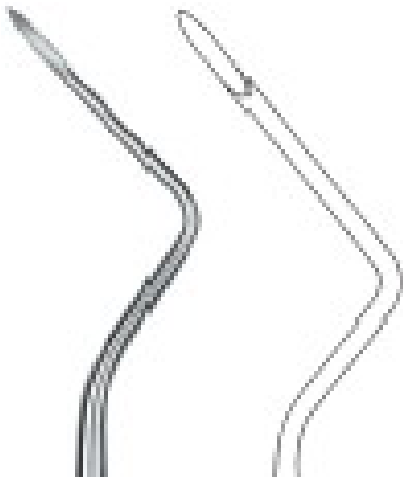

West 3

HD-53-584-03

Root Elevators

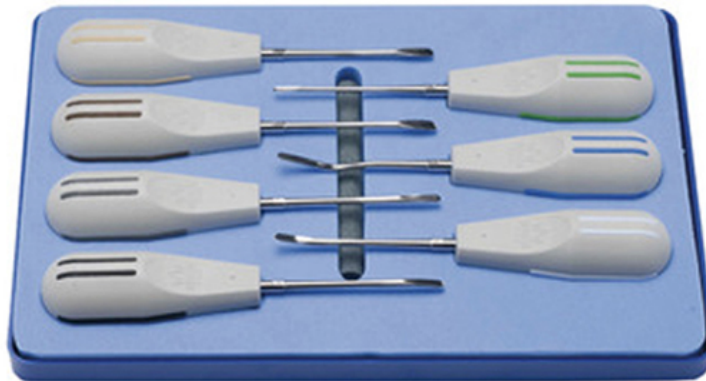

Luxator Set Of 7

HD-53-587-07

Luxator Set Of 7



Luxator Set Of 8

HD-53-588-08

Luxator Set Of 8



Hexagon Handle Elevator

HD-53-589-01

Hexagon Handle Elevator



Freer Elevator

HD-53-585-03

Freer Elevator Double Ended



Joker Elevator

HD-53-586-03

Joker Elevator Available in Solid and Hollow Handle.

Bone Rongeurs



Friedman-Micro 5"

HD-54-107

Bone Rongeurs



Bone Rongeur

HD-54-108

Bone Rongeurs



LUER 6"

HD-54-109

Bone Rongeurs



LUER 6"

HD-54-110

Bone Rongeurs



2A-MEAD, SQUARE TIPS 5"

HD-54-111

Bone Rongeur



BLUMENTHAL 6"

HD-54-112

Bone Rongeur



BLUMENTHAL 45° 6"

HD-54-113

Bone Rongeur



Bone Rongeur 7"

HD-54-114

Bone Rongeur



Bone Rongeur

HD-54-115

Bone Rongeur



BEYER 7"

HD-54-116

Bone Rongeur



MEAD 6½"

HD-54-117

Bone Rongeur



BANE-HEARTMANN 7"

HD-54-118

Bone Rongeur



BEYER DOUBLE-ACTION 7"

HD-54-119

Bone Rongeur



ZUFAL-JANSEN 7"

HD-54-120

Bone Rongeur



Bone Rongeur

HD-54-121

Bone Rongeur



Bone Rongeur

HD-54-122

Bone Rongeur



Cleveland 5"

HD-54-123

Bone Cutting Forceps



Bone Rongeur

HD-54-124

Bone Cutting Forceps

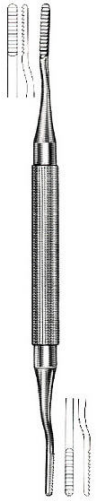

Fig. 1
Polokoff

Polokoff

HD-55-101

Bone Files

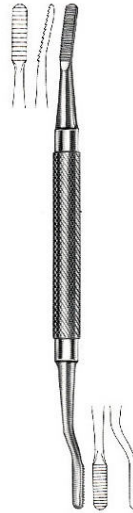

Fig. 33

HD-55-102

Bone Files



Fig. 64
Miler

Miler

HD-55-103

Bone Files



Fig. 45
Miler

Miler

HD-55-104

Bone Files



Fig. 10

HD-55-105

Bone Files



Fig. 1
Wahl

Wahl

HD-55-106

Bone Files



Fig. 2
Wahl

Wahl

HD-55-107

Bone Files



Fig. 12CA

HD-55-108

Bone Files



Fig. 12A

HD-55-109

Bone Files

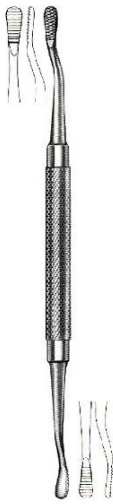

Fig. 12
Howard

Howard

HD-55-110

Bone Files



Fig. 1
Hemingway

Hemingway

HD-56-101

Bone Currettes



Fig. 2
Hemingway

Hemingway

HD-56-102

Bone Currettes



Fig. 3
Hemingway

Hemingway

HD-56-103

Bone Currettes



Fig. 4
Hemingway

Hemingway

HD-56-104

Bone Currettes



Fig. 85
Lucas

Lucas

HD-56-105

Bone Currettes



Fig. 86
Lucas

Lucas

HD-56-106

Bone Currettes



Fig. 87
Lucas

Lucas

HD-56-107

Bone Curettes



Fig. 88
Lucas

Lucas

HD-56-108

Bone Curettes



Fig. 1
Hemingway

Hemingway

HD-56-109

Bone Curettes



Fig. 2
Hemingway

Hemingway

HD-56-110

Bone Curettes



Fig. 3
Hemingway

Hemingway

HD-56-111

Bone Curettes



Fig. 4
Hemingway

Hemingway

HD-56-112

Bone Curettes



Fig. 85
Lucas

Lucas

HD-56-113

Bone Curettes



Fig. 86
Lucas

Lucas

HD-56-114

Bone Curettes



Fig. 87
Lucas

Lucas

HD-56-115

Bone Curettes



Fig. 88
Lucas

Lucas

HD-56-116

Bone Curettes

Cotton & Dressing Tweezers



Cotton & Dressing Tweezers

HD-57-101

Tooth Tweezers



College Tweezer

HD-57-102

Cotton & Dressing Tweezers



College Tweezer Smooth Plan Handle

HD-57-103

Cotton & Dressing Tweezers



Meriam Tweezers

HD-57-104

Cotton & Dressing Tweezers



College Tweezer

HD-57-105

Cotton & Dressing Tweezers



Meriam Tweezers

HD-57-106

Cotton & Dressing Tweezers

Cotton & Dressing Tweezers



Meriam Tweezers

HD-57-107

Cotton & Dressing Tweezers



College Tweezer

HD-57-108

Cotton & Dressing Tweezers



College Tweezer

HD-57-109

Cotton & Dressing Tweezers



Self Locking Tweezer Serr.

HD-57-110

Cotton & Dressing Tweezers



College Tweezer

HD-57-111

Cotton & Dressing Tweezers



College Tweezer

HD-57-112

Cotton & Dressing Tweezers

Cotton & Dressing Tweezers



Perry Tweezer

HD-57-113

Cotton & Dressing Tweezers



HD-57-114

Cotton & Dressing Tweezers



Flagg Tweezer Smooth

HD-57-115

Cotton & Dressing Tweezers



Flagg Tweezer Serrated

HD-57-116

Cotton & Dressing Tweezers



HD-57-117

Cotton & Dressing Tweezers



Cotton & Dressing Tweezers

HD-57-118

Tooth Tweezers

Cotton & Dressing Tweezers



Cotton & Dressing Tweezers

HD-57-119

Tooth Tweezers



Self Locking Tweezer Smooth

HD-57-120

Cotton & Dressing Tweezers



Suture Forcep

HD-57-121

Cotton & Dressing Tweezers

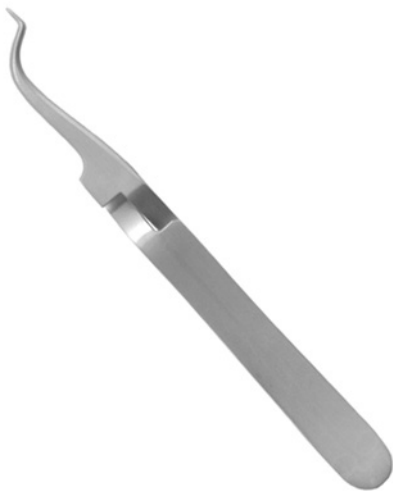

Buccal Tube Holding Tweezer

HD-57-122

Buccal Tube Holding Tweezer.



Bracket Tweezer

HD-57-123

Bracket Placing Tweezer Angled Tip.



Bracket Tweezer

HD-57-124

Bracket Placing Tweezer Rounded.

Cotton & Dressing Tweezers



Bracket Tweezer

HD-57-125

Bracket Placing Tweezer.



Bracket Tweezer

HD-57-126

Bracket Placing Tweezer Angled Tip.



Buccal Tube Tweezer

HD-57-127

Buccal Tube Tweezer.

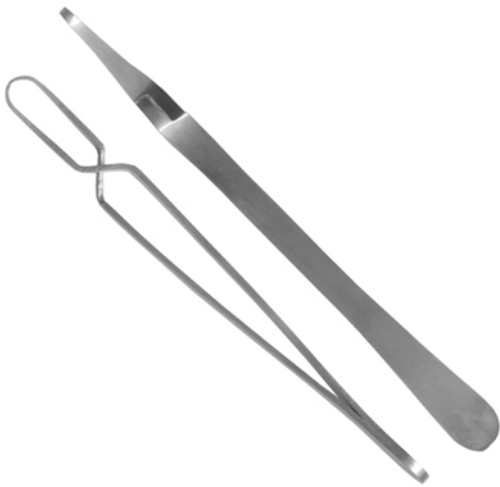

Bracket Tweezer

HD-57-128

Bracket Placing Tweezer X Shape.



Bracket Tweezer

HD-57-129

Bracket Placing Tweezer.

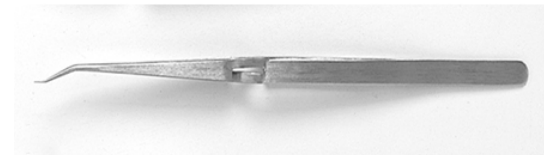

Buccal Tube Holding Tweezer

HD-57-130

Buccal Tube Holding Tweezer.



Bracket Placing Tweezer

HD-57-131

Bracket Placing Tweezer

Rubber Dam Punch & Clamps



Rubber Dam Punch Ivory

HD-58-101

Rubber-Dam Instruments



Anisworth

HD-58-102

Rubber-Dam Instruments



Brewer

HD-58-103

Rubber-Dam Instruments



Palmer

HD-58-104

Rubber-Dam Instruments



BIRD BEAK PLIER

HD-59-101

ORTHODONTIC PLIERS, ANGLE



CUTTING PLIER FOR ORTHODONTICS

HD-59-102

ORTHODONTIC PLIERS NO.1



CUTTING PLIERS FOR ORTHODONTIC

HD-59-103

ORTHODONTIC PLIERS NO.2



DE LA ROSA ORTHO PLIER

HD-59-104

ORTHODONTIC GROOVED PLIERS, DE LA ROSA



Jarabak Pliers

HD-59-105

Jarabak Pliers.



DISTAL END CUTTER

HD-59-106

DISTAL END CUTTER



DISTAL END CUTTER

HD-59-107 ITC



HARD WIRE CUTTER TC

HD-59-108 3TC



MC KELLOPS PLIERS FOR ORTHODON

HD-59-111

ORTHODONTIC PLIERS, MC KELLOPS



LIGHT WIRE CUTTER

HD-59-109

MICRO-MINIATURE WIRE CUTTER



LIGHT WIRE CUTTER

HD-59-110 ITC



ORTHODONTIC PLIERS

HD-59-114

ORTHODONTIC PLIERS TO FORM LINGUAL ARCHES



NANCE PLIERS FOR ORTHODONTICS

HD-59-113

ORTHODONTIC PLIERS NANCE



MICRO DISTAL END CUTTER

HD-59-112

MICRO DISTAL WIRE CUTTER



ORTHODONTIC PLIER

HD-59-115

ORTHODONTIC PLIERS TO REMOVE BRACKETS



ORTHODONTIC PLIER

HD-59-116

ORTHODONTIC ATTACHMENT REMOVER PLIERS



ORTHODONTIC PLIERS

HD-59-117

ORTHODONTIC ATTACHMENTS REMOVER PLIERS



ORTHODONTIC PLIERS

HD-59-118

ORTHODONTIC DIRECT BONDING PLIERS



PLIERS FOR ORTHODONTIC CURVED

HD-59-119

ORTHODONTIC PLIERS HOW NO.2 CURVED



PLIERS FOR ORTHODONTICS

HD-59-120

ORTHODONTIC PLIERS



PLIERS FOR ORTHODONTICS

HD-59-121

ORTHODONTIC PLIERS NO.2



PLIERS FOR ORTHODONTICS

HD-59-122

ORTHODONTIC PLIERS WITH SMOOTH BEAKS



PLIERS FOR ORTHODONTICS

HD-59-123

ORTHODONTIC PLIERS NO.2



PLIERS FOR ORTHODONTICS

HD-59-124

ORTHODONTIC CONTOURING PLIERS, REYNOLDS



PLIERS FOR ORTHODONTICS

HD-59-125

ORTHODONTIC PLIERS, WALDSACHS



PLIERS FOR ORTHODONTICS

HD-59-126

ORTHODONTIC PLIERS JOHNSON



PLIERS FOR ORTHODONTICS

HD-59-127

ORTHODONTIC PLIERS, NANCE



PLIERS FOR ORTHODONTICS

HD-59-128

ORTHODONTIC PLIERS, YOUNG



PLIERS FOR ORTHODONTICS

HD-59-129

ORTHODONTIC PLIERS



PLIERS FOR ORTHODONTICS

HD-59-130

ORTHODONTIC PLIERS WITH ROUNDED JAW



PLIERS FOR ORTHODONTICS

HD-59-131

ORTHODONTIC PLIERS, ANGLE



PLIERS FOR ORTHODONTICS

HD-59-132

ORTHODONTIC PLIERS, ADAMS



PLIERS FOR ORTHODONTICS

HD-59-133

ORTHODONTIC PLIERS WITH ROUND NOSE



PLIERS FOR ORTHODONTICS

HD-59-134

ORTHODONTIC PLIERS, ADERER



PLIERS FOR ORTHODONTICS

HD-59-135

ORTHODONTIC PLIERS ADERER



PLIERS FOR ORTHODONTICS

HD-59-136

ORTHODONTIC PLIERS, TWEED



PLIERS FOR ORTHODONTICS

HD-59-137

ORTHODONTIC PLIERS



PLIERS FOR ORTHODONTICS

HD-59-138

ORTHODONTIC PLIERS, ANGLE NO.1



PLIERS FOR ORTHODONTICS STR.

HD-59-139

ORTHODONTIC PLIERS HOW NO.1 STRAIGHT



POSTERIOR BAND REMOVER

HD-59-140

ORTHODONTIC BAND REMOVER PLIERS



POSTERIOR BAND REMOVER

HD-59-141

ORTHODONTIC BAND REMOVER PLIERS



UNIVERSAL PLIERS FOR ORTHODON.

HD-59-142

UNIVERSAL ORTHODONTIC PLIERS



UNIVERSAL ORTHO PLIERS

HD-59-143

UNIVERSAL BENDING ORTHODONTIC PLIERS



ROUND AND CONCAVE PLIERS

HD-59-144

ORTHODONTIC PLIERS, ROUND AND CONCAVE



TWEED ORTHO PLIER

HD-59-145

ORTHODONTIC PLIERS, TWEED



TWEED ORTHO PLIERS

HD-59-146

ORTHODONTIC PLIERS, TWEED



TWEED ORTHO PLIERS

HD-59-147

ORTHODONTIC LOOP FORMING PLIERS, TWEED



WEINGART ORTHO PLIERS

HD-59-148

ORTHODONTIC UNIVERSAL PLIERS, WEINGART



WIRE CUTTER

HD-59-151

WIRE CUTTER FOR ANY SIZE LIGATURE WIRES



WIRE CUTTER

HD-59-152 ITC



HARD WIRE CUTTER TC

HD-59-153-3TC



Mini Ligature Cutter TC

HD-59-161

Mini Ligature Cutter TC With Slim Pattern.



Posterior Band Removers TC

HD-59-163

Posterior Band Remover TC Slim Patern.



Ligature Wire Cutter

HD-59-154

Ligature Wire Cutter Tc With Long Handle.



Ligature Wire Cutter Angle

HD-59-155

Ligature wire cutter plier with the advantage of 15 degrees angle for easier access to the posterior area.



Hard Wire Cutter Tc

HD-59-156

Hard Wire Cutter Tc.



How Plier

HD-59-158

The How Pliers is designed to firmly grip the tie-wing from attachment of the band, preventing slippage when in use.



Occulist Plier

HD-59-159

Round and concave beaks are hardened stainless steel and have an extra smooth finish. Bends round or rectangular wire with a firm grip that will not nick wire. Bends wires up to .020



Cinch Back Plier

HD-59-160

Niti Cinch Back Pliers Serrated jaws. The slim line design allows quick and easy bending of distal ends inside the mouth.



Weingart Pliers Narrow

HD-59-164

Weingart Pliers Narrow Serrated tips hold archwires firmly in the mouth. Also Available in TC Tips.



Step Pliers

HD-59-165

Step pliers are designed to make it easier for clinicians to create Z-bends in archwire. step pliers, also known as detailing pliers or bayonet bending pliers, are best used extraorally on wire up to



Hook Crimping Pliers

HD-59-166

Hook Crimping Pliers.



Regular Crown Crimping Pliers

HD-59-167

Designed to crimp gingival margins of all stainless steel, aluminum and polycarbonate crowns to insure tight fit.

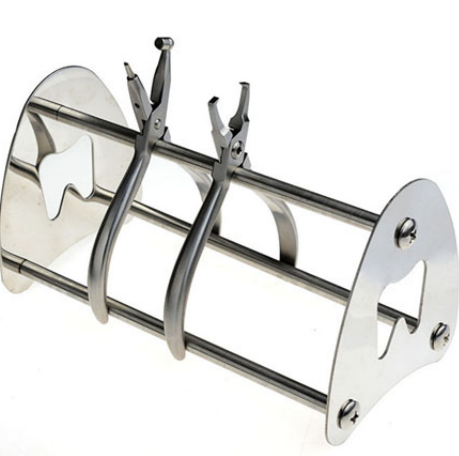

Pliers Rack

HD-59-168

Stainless Steel Rack for Orthodontic Pliers.



Pliers Rack

HD-59-169

Stainless Steel Rack for Orthodontic Pliers.



Pliers Rack

HD-59-170

Stainless Steel Rack for Orthodontic Pliers.

Orthodontic Pliers



Pliers Rack Teeth Shape

HD-59-171

Pliers Rack Teeth Shape



Distal End Cutter TC Mini

HD-59-162

Distal End Cutter TC Slim Pattern.



The Hole Punch

HD-59-172

The Hole Punch Plier creates half-moon cutouts for relief of clear aligners around bonded buttons used for elastics and nips away plastic to provide soft tissue clearance to prevent aligner impinge



The Tear Drop

HD-59-173

The Tear Drop Creates a notch at the gingival margin of clear aligners anywhere elastic hooks are required.



The Horizontal

HD-59-174

The Horizontal Plier Produces an indentation to accent individual root torque..



The Vertical

HD-59-175

The Vertical Emphasizes over-correction of rotations by producing an indentation at the mesial or distal line angles on the facial and/or lingual of a specific tooth.



NiTi Distal Cinch Back Plier

HD-59-176

NiTi Distal Cinch Back Plier With Long Handle.



DISTAL END SAFETY CUTTER WITH LONG HANDLE - SLIM

HD-59-177

DISTAL END SAFETY CUTTER WITH LONG HANDLE - SLIM (CARBIDE TIP) Easy access to tight areas and second molars Safety hold feature Maximum Cutting Capacity Rectangular w



SAFETY HOLD FLUSH CUT

HD-59-178

Hold the wire then cut distally flush to the buccal tube or bracket while reducing debondings. C



Distal End Cutter TC

HD-59-179

Cut and Hold wires.



Hard Wire Cutter TC

HD-59-180

Can easily cut and holds wire all types of wires ranging from .012" (.30 mm) to .021" x .025" (.53 mm x .64 mm)



Ligature Cutter TC

HD-59-181

Cuts pins, ligatures and elastics up to .015"(.38 mm)
130mm Long



Hamerhead NiTi Cinch Back Pliers

HD-59-182

Cinches and bends NiTi archwire intra-orally distal



Bird Beak Plier With Groove

HD-59-183

Bird beak plier with groove is useful for forming precise loops in light wires up to .020" (.51 mm).



Arch Bending Plier

HD-59-184

Arch bending Plier first, second and third order bends on stainless steel wires up to .022" x .025" (.56 mm x .64 mm).



Hollow Chop Arch Forming Plier

HD-59-185

Hollow Chop Arch Forming Plier the smooth concave and convex lain surface allows forming of archwires easily.



Crile-Murray

HD-60-101

Needle Holders



Mayo-Hegar

HD-60-102

Needle Holders



Crile-Murray

HD-60-103

Needle Holders



Mayo-Hegar

HD-60-104

Needle Holders



Mayo-Hegar

HD-60-105

Needle Holders



Mayo-Hegar

HD-60-106

Needle Holders

Needle Holders



Olsen-Hegar

HD-60-107

Needle Holders



Gillies

HD-60-108

Needle Holders



Boynton

HD-60-109

Needle Holders



Mathieu

HD-60-110

Needle Holders



Mathieu

HD-60-111

Needle Holders



Crile

HD-60-112

Needle Holders



Toennis

HD-60-113

Needle Holders



Mayo-Hegar

HD-60-114

Needle Holders



Mayo-Hegar

HD-60-115

Needle Holders



Mayo-Hegar

HD-60-116

Needle Holders



Mayo-Hegar

HD-60-117

Needle Holders



Debakey

HD-60-118

Needle Holders



Debakey

HD-60-119

Needle Holders



Ryder

HD-60-120

Needle Holders



Ryder

HD-75-121

Needle Holders



Ryder 7 CARB-N-SERT Jaws

HD-60-122

Needle Holders



Bozemann 5

HD-60-123

Needle Holders



Olsen-Hegar CARB-N-SERT Jaws

HD-60-124

Needle Holders



Olsen-Hegar CARB-N-SERT Jaws

HD-60-125

Needle Holders



Olsen-Hegar CARB-N-SERT Jaws

HD-60-126

Needle Holders



Olsen-Hegar CARB-N-SERT Jaws

HD-60-127

Needle Holders



Needle Holders

HD-60-128

Needle Holders



Needle Holders

HD-60-129

Needle Holders



Ryder 8 CARB-N-SERT Jaws

HD-60-130

Needle Holders



Needle Holders

HD-60-131

Needle Holders



Mathieu 5

HD-60-132

Needle Holders



TC Mathieu Needle Holder

HD-60-133

TC Mathieu Needle Holders Double Spring.

14cm



Mathieu 8

HD-60-134

Needle Holders



Mathieu 5

HD-60-135

Needle Holders



Mathieu 6

HD-60-136

Needle Holders



Mathieu 8

HD-60-137

Needle Holders



Mathieu 7

HD-60-138

Needle Holders



Mathieu CARB-N-SERT Jaws

HD-60-139

Needle Holders



LISTER Bandage Scissors

HD-61-101

GUM Scissors
Extra fine



LISTER Bandage Scissors

HD-61-102

Gum Scissors
Extra fine



LISTER Bandage Scissors

HD-61-103

Gum Scissors
Extra fine



KNOWLES Bandage Scissors

HD-61-104

Gum Scissors
Straight



HEATH Suture Scissors

HD-61-105

Gum Scissors
Serrated blade



SPENCER Stitch Scissors

HD-61-106

Gum Scissors
Delicate



SHORTBENT Stitch Scissors

HD-61-107

Gum Scissors
Curved delicate



LITTAUER JR. Stitch Scissors

HD-61-108

Gum Scissors



NORTHBENT Stitch Scissors

HD-61-109

Gum Scissors
Curved light pattern



LITTAUER Stitch Scissors

HD-61-110

Gum Scissors
Standard pattern



LONG Oral Surgery Stitch Scissors

HD-61-111

Gum Scissors



MILTEX Stitch Scissors

HD-61-112

Gum Scissors
Angled delicate

Gum Scissors



REEH Stitch Scissors

HD-61-113

Gum Scissors

Sharp tips small hook on 1 blade ribbon type



MILTEX Stitch Scissors

HD-61-114

Gum Scissors

Curved sharp pointed tips ribbon type



MILTEX Stitch Scissors

HD-61-115

Gum Scissors

Curved sharp pointed tips ribbon type



Crown Scissors Serrated

HD-61-116

Serrated Crown Scissors Str & Crv.



Crown Scissor

HD-61-117

Crown Scissors straight and curved stainless steel.



MILTEX Wire Cutting Scissors

HD-61-118

Gum Scissors

Angled to side one serrated blade



MILTEX Wire Cutting Scissors

HD-61-119

Gum Scissors

Angled to side, one serrated blade, Carb-N-Sert inserts



Standard Pattern Operating Scissors

HD-61-120

Gum Scissors

Straight sharp-sharp points



Standard Pattern Operating Scissors

HD-61-121

Gum Scissors

Straight sharp-sharp points



Standard Pattern Operating Scissors

HD-61-122

Gum Scissors

Straight sharp-blunt points



Standard Pattern Operating Scissors

HD-61-123

Gum Scissors

Straight sharp-blunt points



Standard Pattern Operating Scissors

HD-61-124

Gum Scissors

Straight sharp-blunt points



Standard Pattern Operating Scissors

HD-61-125

Gum Scissors
Curved sharp/sharp points



Standard Pattern Operating Scissors

HD-61-126

Gum Scissors
Curved sharp/sharp points



Standard Pattern Operating Scissors

HD-61-127

Gum Scissors
Curved



Standard Pattern Operating Scissors

HD-61-128

Gum Scissors
Curved, sharp-blunt points



MAYO Dissecting Scissors

HD-61-129

Gum Scissors
Straight, standard beveled blades



MAYO Dissecting Scissors

HD-61-130

Gum Scissors
Straight, standard beveled blades



MAYO Dissecting Scissors

HD-61-131

Gum Scissors
Curved, standard beveled blades



MAYO Dissecting Scissors

HD-61-132

Gum Scissors
Curved, standard beveled blades



Delicate Pattern METZENBAUM Scissors

HD-61-133

Gum Scissors
Straight, blunt points



Delicate Pattern METZENBAUM Scissors

HD-61-134

Gum Scissors
Straight, sharp points



Standard Pattern METZENBAUM Scissors

HD-61-135

Gum Scissors
Curved, blunt points



Standard Pattern METZENBAUM Scissors

HD-61-136

Gum Scissors
Curved, blunt points



Delicate Pattern METZENBAUM Scissors

HD-61-137

Gum Scissors
Curved, blunt points



Delicate Pattern METZENBAUM Scissors

HD-61-138

Gum Scissors
Curved, sharp points



KELLY Scissors

HD-61-139

Gum Scissors
Straight, sharp points



KELLY Scissors

HD-61-140

Gum Scissors
Curved, sharp points



KELLY Scissors

HD-61-141

Gum Scissors
Sharp points, angled on side



KAYE Blepharoplasty And Dissecting Scissors

HD-61-142

Gum Scissors
One serrated blade, ribbon type



DEAN Dissecting Scissors

HD-61-143

Gum Scissors

Blades angled on flat, one serrated blade



KAYE Dissecting Scissors

HD-61-144

Gum Scissors

Curved, one serrated blade



WAGNER Plastic Surgery Scissors

HD-61-145

Gum Scissors

Straight, sharp-sharp points, serrated blade



WAGNER Plastic Surgery Scissors

HD-61-146

Gum Scissors

Straight, sharp-sharp points, serrated blade



WAGNER Plastic Surgery Scissors

HD-61-147

Gum Scissors

Straight, sharp-blunt points



WAGNER Plastic Surgery Scissors

HD-61-148

Gum Scissors

Straight, sharp-blunt points, serrated blade



WAGNER Plastic Surgery Scissors

HD-61-149

Gum Scissors
Straight, blunt-blunt points



WAGNER Plastic Surgery Scissors

HD-61-150

Gum Scissors
Straight, blunt-blunt points, serrated blade



WAGNER Plastic Surgery Scissors

HD-61-151

Gum Scissors
Curved, sharp-sharp points



WAGNER Plastic Surgery Scissors

HD-61-152

Gum Scissors
Curved, sharp-sharp points, serrated blade



WAGNER Plastic Surgery Scissors

HD-61-153

Gum Scissors
Curved, sharp-blunt points



WAGNER Plastic Surgery Scissors

HD-61-154

Gum Scissors
Curved, sharp-blunt points, serrated blade



WAGNER Plastic Surgery Scissors

HD-61-155

Gum Scissors
Curved, blunt-blunt points



WAGNER Plastic Surgery Scissors

HD-61-156

Gum Scissors
Curved, blunt-blunt points, serrated blade



WAGNER Plastic Surgery Scissors

HD-61-157

Gum Scissors
Straight, sharp-sharp points



WAGNER Plastic Surgery Scissors

HD-61-158

Gum Scissors
Straight, sharp-sharp point, serrated blade



Delicate Pattern METZENBAUM Scissors

HD-61-159

Gum Scissors
Curved



Iris Scissors

HD-61-160

Gum Scissors
Straight



Iris Scissors

HD-61-161

Gum Scissors
Curved



Iris Scissors

HD-61-162

Gum Scissors
Straight



Iris Scissors

HD-61-163

Gum Scissors
Straight



Iris Scissors

HD-61-164

Gum Scissors
Curved



Iris Scissors

HD-61-165

Gum Scissors
Curved



Iris Scissors

HD-61-166

Gum Scissors
Angled on side



BROPHY Scissors

HD-61-167

Gum Scissors
Straight, sharp points



BROPHY Scissors

HD-61-168

Gum Scissors
Curved, sharp points



GOLDMAN-FOX Scissors

HD-61-169

Gum Scissors
Curved fine tips, one serrated blade



GOLDMAN-FOX Scissors

HD-61-170

Gum Scissors
Curved fine tips, one serrated blade



KELLY Scissors

HD-61-171

Gum Scissors
Sharp points, straight, one serrated blade



KELLY Scissors

HD-61-172

Gum Scissors
Sharp points, curved, one serrated blade



KELLY Scissors

HD-61-173

Gum Scissors

Sharp points, angular, one serrated blade



Iris Operating Scissors

HD-61-174

Gum Scissors

Curved sideways



GOLDMAN-FOX Scissors

HD-61-175

Gum Scissors

Curved, one serrated blade, angled shank



LA GRANGE Scissors

HD-61-176

Gum Scissors

Curved, one serrated blade, angled shank



BROPHY Operating Scissors

HD-61-177

Gum Scissors

Curved, sharp/sharp, with one serrated blade



LOCKLIN Operating Scissors

HD-61-178

Gum Scissors

Angled on side 25 degrees, one serrated blade



LOCKLIN Operating Scissors

HD-61-179

Gum Scissors
Curved shank, angled on side 25 degrees, one serrated blade



**MILTEX SuperCut GOLDMAN-FOX
Gum Scissors**

HD-61-180

Gum Scissors
Curved



HEATH Suture Scissors

HD-61-181

Gum Scissors
Serrated blade



Iris Scissors

HD-61-182

Gum Scissors
Straight, with 20 mm blades, delicate



Iris Scissors

HD-61-183

Gum Scissors
Curved, with 20 mm blades, delicate



NOYES (ROSS) Iris Scissors

HD-61-184

Gum Scissors
Curved, sharp/sharp points



CASTROVIEJO Corneal Scissors

HD-61-185

Gum Scissors
Curved, sharp points



QUIMBY Gum Scissors

HD-61-186

Gum Scissors
Strongly curved and pointed, smooth blades 15 mm



JOSEPH Scissors

HD-61-187

Gum Scissors
Straight



JOSEPH Scissors

HD-61-188

Gum Scissors
Curved

Amalgam Instruments

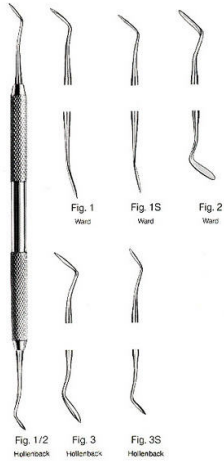

Hollenback

HD-62-101

Amalgam Instruments

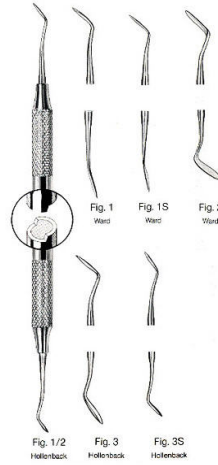

Hollenback

HD-62-107

Amalgam Instruments



Mortonson 1

HD-62-113

Amalgam Instruments



HD-62-114

Amalgam Instruments



HD-62-115

Amalgam Instruments



HD-62-116

Amalgam Instruments

Amalgam Instruments



Fig. SHO-A

HD-62-117

Amalgam Instruments



Fig. 3-SHO

HD-62-118

Amalgam Instruments



Fig. 104

HD-62-119

Amalgam Instruments



Fig. 8

HD-62-120

Amalgam Instruments



Fig. 1

HD-62-121

Amalgam Instruments



Fig. 2

HD-62-122

Amalgam Instruments

Amalgam Instruments



Fig 3

HD-62-123

Amalgam Instruments



Fig 4

HD-62-124

Amalgam Instruments



Fig. SHO-A

HD-62-125

Amalgam Instruments



Fig. 3-SHO

HD-62-126

Amalgam Instruments



Fig. 104

HD-62-127

Amalgam Instruments



Fig. 8

HD-62-128

Amalgam Instruments

Amalgam Instruments



HD-62-129

Amalgam Instruments



HD-62-130

Amalgam Instruments



HD-62-131

Amalgam Instruments



HD-62-132

Amalgam Instruments



HD-62-133

Amalgam Instruments



HD-62-134

Amalgam Instruments

Amalgam Instruments



HD-62-135

Amalgam Instruments



HD-62-136

Amalgam Instruments



Toffemire-Universal

HD-62-137

Amalgam Instruments



HD-62-142

Amalgam Instruments



Amalgam Instruments

HD-62-143

Amalgam Pistolen



Amalgam Instruments

HD-62-144

Amalgam Pistolen

Amalgam Instruments



Amalgam Instruments

HD-62-145

Amalgam Pistolen



Amalgam Instruments

HD-62-146

Amalgam Pistolen



Amalgam Carrier

HD-62-147

?



Amalgam Carrier

HD-62-148

?



Amalgam Carrier

HD-62-149

?

Mouth Gags & Retractor



Heister

HD-63-141

Mouth Gags,



MOLT PEDIATRIC

HD-63-142

Mouth Gags,



MOLT CHILD

HD-63-143

Mouth Gags,



MOLT ADULT

HD-63-144

Mouth Gags,



FERGUSON-ACKLAND

HD-63-145

Mouth Gags,



DENHART

HD-63-146

Mouth Gags,

Mouth Gags & Retractor



ROSER-KONIG

HD-63-147

Mouth Gags,



ROSER-KONIG

HD-63-148

Mouth Gags,



LANGENBECK

HD-63-149

Finger Protectors



HD-63-150

Tongue Depressor and Cheek Retractors

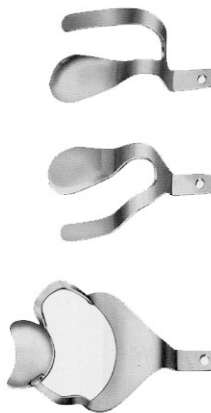

Retractor

HD-63-151

Mouth Gags,



Retractor

HD-63-153

Mouth Gags,

Mouth Gags & Retractor

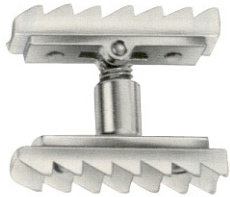

SCHMID

HD-63-154

Mouth Gags,



Retractor

HD-63-155

Mouth Props



Retractor

HD-63-156

Retractors



VESTIBULUM RETRACTOR

HD-63-157

Retractors



STERNBERG

HD-63-158

Retractors



ROUX

HD-63-159

Retractors

Mouth Gags & Retractor



ROUX

HD-63-160

Retractors



ROUX

HD-63-161

Retractors



MIDDELDORPF

HD-63-162

Retractors



MIDDELDORPF

HD-63-163

Retractors



MIDDELDORPF

HD-63-164

Cheek Retractors



Gauze Case

HD-63-165

Gauze Case

Mouth Gags & Retractor



Retractor

HD-63-166

Retractors



Retractor

HD-63-167

Retractors



Retractor

HD-63-168

Retractors



Retractor

HD-63-169

Retractors



Retractor

HD-63-170

Retractors



Retractor

HD-63-171

Retractors

Mouth Gags & Retractor



Retractor

HD-63-172

Retractors



Retractor

HD-63-173

Retractors



Retractor

HD-63-174

Retractors



Retractor

HD-63-175

Retractors



LANGENBECK-GREEN

HD-63-176

Retractors

Periodontia Instruments



Fig. 72
115/ 62
Kirkland

Kirkland

HD-64-101

Periodontia Instruments



Fig. 1/2
Orban

Orban

HD-64-102

Periodontia Instruments



Fig. 1/2
115/ 62
Kirkland

Kirkland

HD-64-103

Periodontia Instruments



Fig. 1/2
Orban

Orban

HD-64-104

Periodontia Instruments



Fig. 7
Goldman-Fox

Goldman-Fox

HD-64-105

Periodontia Instruments



Fig. 8
Goldman-Fox

Goldman-Fox

HD-64-106

Periodontia Instruments

Periodontia Instruments



Fig. 72
115/ 62
Kirkland

Kirkland

HD-64-101

Periodontia Instruments



Fig. 1/2
Orban

Orban

HD-64-102

Periodontia Instruments



Fig. 1/2
115/ 62
Kirkland

Kirkland

HD-64-103

Periodontia Instruments



Fig. 1/2
Orban

Orban

HD-64-104

Periodontia Instruments



Fig. 7
Goldman-Fox

Goldman-Fox

HD-64-105

Periodontia Instruments



Fig. 8
Goldman-Fox

Goldman-Fox

HD-64-106

Periodontia Instruments

Periodontia Instruments



Fig. 9
Goldman-Fox

Goldman-Fox

HD-64-107

Periodontia Instruments



Fig. 11
Goldman-Fox

Goldman-Fox

HD-64-108

Periodontia Instruments



Fig. 3/4
Buck

Buck

HD-64-109

Periodontia Instruments



Fig. 5/6
Buck

Buck

HD-64-110

Periodontia Instruments



Fig. 7
Goldman-Fox

Goldman-Fox

HD-64-111

Periodontia Instruments



Fig. 8
Goldman-Fox

Goldman-Fox

HD-64-112

Periodontia Instruments

Periodontia Instruments



Fig. 9
Goldman-Fox

Goldman-Fox

HD-64-113

Periodontia Instruments



Fig. 11
Goldman-Fox

Goldman-Fox

HD-64-114

Periodontia Instruments



Fig. 3/4
Buck

Buck

HD-64-115

Periodontia Instruments



Fig. 5/6
Buck

Buck

HD-64-116

Periodontia Instruments



Fig. 1/2
Sanders

Sanders

HD-64-117

Periodontia Instruments



Fig. 4/5
Sanders

Sanders

HD-64-118

Periodontia Instruments

Periodontia Instruments



Fig. 18/20

OCHSENBEIN CHISEL NO 4

HD-64-119

Periodontia Instruments



Fig. 6/6
Buck

Crane-Kaplan

HD-64-120

Periodontia Instruments



Fig. 1/2
Sankin

Sanders

HD-64-121

Periodontia Instruments



Fig. 4/5
Sanders

Sanders

HD-64-122

Periodontia Instruments



Fig. 19/20

OCHSENBEIN CHISEL NO 4

HD-64-123

Periodontal Instruments



Fig. CK3
Crane-Kaplan

Crane-Kaplan

HD-64-124

Periodontia Instruments

Periodontia Instruments



Fig. HU 1/2
Curette

Curette

HD-64-125

Periodontia Instruments



Fig. 2R/2L
Columbia

Columbia

HD-64-126

Periodontia Instruments



Fig. 4R/4L
Columbia

Columbia

HD-64-127

Periodontia Instruments



Fig. 13/14
Columbia

Columbia

HD-64-128

Periodontia Instruments



Fig. 411/412

HD-64-129

Periodontia Instruments



Fig. 4'3/414

HD-64-130

Periodontia Instruments

Periodontia Instruments



Zerling-Chiles

Zerling-Chiles

HD-64-131

Periodontia Instruments



Fig. HU 1/2
Curette

Curette

HD-64-132

Periodontia Instruments



Fig. 29/2L
Columbia

Columbia

HD-64-133

Periodontia Instruments



Fig. 4R/4L
Columbia

Columbia

HD-64-134

Periodontia Instruments



Fig. 13/14
Columbia

Columbia

HD-64-135

Periodontia Instruments



Fig. 1/2
Langer

Langer

HD-64-136

Periodontia Instruments

Periodontia Instruments



Fig. 3/4
Langer

Langer

HD-64-137

Periodontia Instruments



Fig. 1/2
Barnhart

Barnhart

HD-64-138

Periodontia Instruments



Fig. 5/6
Barnhart

Barnhart

HD-64-139

Periodontia Instruments



Fig. ME-1
(TV11)

HD-64-140

Periodontia Instruments



Fig. 2/4
Puro 123/24

HD-64-141

Periodontia Instruments



Fig. 1/2
Langer

Langer

HD-64-142

Periodontia Instruments

Periodontia Instruments



Fig. 3/4
Langer

Langer

HD-64-143

Periodontia Instruments



Fig. 1/2
Barnhart

Barnhart

HD-64-144

Periodontia Instruments



Fig. 5/6
Barnhart

Barnhart

HD-64-145

Periodontia Instruments



Fig. ME-1
[10/11]

HD-64-146

Periodontia Instruments



Fig. 3/4
Rue (23/24)

HD-64-147

Periodontia Instruments



Fig. 1/2
Gracey

Gracey

HD-64-148

Periodontia Instruments

Periodontia Instruments



Fig. 3/4
Gracey

Gracey

HD-64-149

Periodontia Instruments



Fig. 5/6
Gracey

Gracey

HD-64-150

Periodontia Instruments



Fig. 7/8
Gracey

Gracey

HD-64-151

Periodontia Instruments



Fig. 9/10
Gracey

Gracey

HD-64-152

Periodontia Instruments



Fig. 11/12
Gracey

Gracey

HD-64-153

Periodontia Instruments



Fig. 13/14
Gracey

Gracey

HD-64-154

Periodontia Instruments

Periodontia Instruments



Fig. 1/2
Gracey

Gracey

HD-64-155

Periodontia Instruments



Fig. 3/4
Gracey

Gracey

HD-64-156

Periodontia Instruments



Fig. 5/6
Gracey

Gracey

HD-64-157

Periodontia Instruments



Fig. 7/8
Gracey

Gracey

HD-64-158

Periodontia Instruments



Fig. 9/10
Gracey

Gracey

HD-64-159

Periodontia Instruments



Fig. 11/12
Gracey

Gracey

HD-64-160

Periodontia Instruments

Periodontia Instruments



Fig. 13/14
Gracey

Gracey

HD-64-161

Periodontia Instruments



Fig. 11/14
Gracey

Gracey

HD-64-162

Periodontia Instruments



Fig. 12/13
Gracey

Gracey

HD-64-163

Periodontia Instruments



Fig. 1
De Marco

Ce Marco

HD-64-164

Periodontia Instruments



Fig. 2
De Marco

De Marco

HD-64-165

Periodontia Instruments



Fig. 13/14
Anterior

Anterior

HD-64-166

Periodontia Instruments

Periodontia Instruments



Fig. 17/18
Posterior

Posterior

HD-64-167

Periodontia Instruments



Fig. 11/14
Gracey

Gracey

HD-64-168

Periodontia Instruments



Fig. 12/13
Gracey

Gracey

HD-64-169

Periodontia Instruments



Fig. 1
De Marco

De Marco

HD-64-170

Periodontia Instruments



Fig. 2
De Marco

De Marco

HD-64-171

Periodontia Instruments



Fig. 13/14
Anterior

Anterior

HD-64-172

Periodontia Instruments

Periodontia Instruments



Fig. 177/18
Poserior

Poserior

HD-64-173

Periodontia Instruments



Fig. 1
Goldman-Fox

Goldman-Fox

HD-64-174

Periodontia Instruments



Fig. 2
Goldman-Fox

Goldman-Fox

HD-64-175

Periodontia Instruments



Fig. 3
Goldman-Fox

Goldman-Fox

HD-64-176

Periodontia Instruments



Fig. 4
Goldman-Fox

Goldman-Fox

HD-64-177

Periodontia Instruments



Fig. 5
Goldman-Fox

Goldman-Fox

HD-64-178

Periodontia Instruments

Periodontia Instruments



Fig. 6
Goldman-Fox

Goldman-Fox

HD-64-179

Periodontia Instruments



Fig. 71
Goldman-Fox

Goldman-Fox

HD-64-180

Periodontia Instruments



Fig. 1
Goldman-Fox

Goldman-Fox

HD-64-181

Periodontia Instruments



Fig. 2
Goldman-Fox

Goldman-Fox

HD-64-182

Periodontia Instruments



Fig. 3
Goldman-Fox

Goldman-Fox

HD-64-183

Periodontia Instruments



Fig. 4
Goldman-Fox

Goldman-Fox

HD-64-184

Periodontia Instruments

Periodontia Instruments



Fig. 5
Goldman-Fox

Goldman-Fox

HD-64-185

Periodontia Instruments



Fig. 6
Goldman-Fox

Goldman-Fox

HD-64-186

Periodontia Instruments



Fig. 21
Goldman-Fox

Goldman-Fox

HD-64-187

Periodontia Instruments



Fig. 11/12
Mc Call

Mc Call

HD-64-188

Periodontia Instruments



Fig. 11A/12A
Mc Call

Mc Call

HD-64-189

Periodontia Instruments



Fig. 13/14
Mc Call

Mc Call

HD-64-190

Periodontia Instruments

Periodontia Instruments



Fig. 13S/14S
Mc Call

Mc Call

HD-64-191

Periodontia Instruments



Fig. 17S/18S
Mc Call

Mc Call

HD-64-192

Periodontia Instruments



Fig. 19/20
Mc Call

Mc Call

HD-64-193

Periodontia Instruments



Fig. 11/12
Mc Call

Mc Call

HD-64-194

Periodontia Instruments



Fig. 11A/12A
Mc Call

Mc Call

HD-64-195

Periodontia Instruments



Fig. 13/14
Mc Call

Mc Call

HD-64-196

Periodontia Instruments

Periodontia Instruments



Fig. 125/116S
Mc Call

Mc Call

HD-64-197

Periodontia Instruments



Fig. 175/185
Mc Call

Mc Call

HD-64-198

Periodontia Instruments



Fig. 19/20
Mc Call

Mc Call

HD-64-199

Periodontia Instruments



Fig. 2/3
Taylor

Taylor

HD-64-200

Periodontia Instruments



Fig. 204

HD-64-201

Periodontia Instruments



Fig. 204S

HD-64-202

Periodontia Instruments

Periodontia Instruments



Fig. 204S

HD-64-203

Periodontia Instruments



Fig. 6
Crane-Kaplan

Crane-Kaplan

HD-64-204

Periodontia Instruments



Fig. 7/0
Younger-Good

Younger-Good

HD-64-205

Periodontia Instruments



Fig. 273
Taylor

Taylor

HD-64-206

Periodontia Instruments



Fig. 204

HD-64-207

Periodontia Instruments



Fig. 204G

HD-64-208

Periodontia Instruments

Periodontia Instruments



Fig. 2045

HD-64-209

Periodontia Instruments



Fig. 5
Crane-Kaplan

Crane-Kaplan

HD-64-210

Periodontia Instruments



Fig. 7/8
Younger-Good

Younger-Good

HD-64-211

Periodontia Instruments



Fig. 3/7
Hirschfeld

Hirschfeld

HD-64-212

Periodontia Instruments



Fig. 30/33
Jaquette

Jaquette

HD-64-213

Periodontia Instruments



Fig. 31/32
Jaquette

Jaquette

HD-64-214

Periodontia Instruments

Periodontia Instruments



Fig. 31/32
Jaquette

Jaquette

HD-64-215

Periodontia Instruments



Fig. 317
Hirschfeld

Hirschfeld

HD-64-216

Periodontia Instruments



Fig. 30/33
Jaquette

Jaquette

HD-64-217

Periodontia Instruments



Fig. 31/22
Jaquette

Jaquette

HD-64-218

Periodontia Instruments



Fig. 34/35
Jaquette

Jaquette

HD-64-219

Periodontia Instruments



Fig. 37/38
Jaquette

Jaquette

HD-64-220

Periodontia Instruments

Periodontia Instruments



Fig. 1
Ochsenbein

Ochsenbein

HD-64-221

Periodontia Instruments



Fig. 2
Ochsenbein

Ochsenbein

HD-64-222

Periodontia Instruments



Fig. 1
Gardner

Gardner

HD-64-223

Periodontia Instruments



Fig. 2
Gardner

Gardner

HD-64-224

Periodontia Instruments



Fig. 5
Gardner

Gardner

HD-64-225

Periodontia Instruments



Fig. 5R
Gardner

Gardner

HD-64-226

Periodontia Instruments

Periodontia Instruments



Fig. 6
Gardner

Gardner

HD-64-227

Periodontia Instruments



Fig. 1W
Wakef old

Wakef Old

HD-64-228

Periodontia Instruments



Fig. 2W
Wakef old

Wakef Old

HD-64-229

Periodontia Instruments



Fig. 3
Buckley

Buckley

HD-64-230

Periodontia Instruments



Fig. MB
Molt

Molt

HD-64-231

Periodontia Instruments



Fig. PR3
Prichard

Prichard

HD-64-232

Periodontia Instruments

Periodontia Instruments



Fig. 1
Hopkins

Hopkins

HD-64-233

Periodontia Instruments



Fig. 2
Hopkins

Hopkins

HD-64-234

Periodontia Instruments



Fig. 5
Frerr

Frerr

HD-64-235

Periodontia Instruments



Fig. 16
Frerr

Frerr

HD-64-236

Periodontia Instruments



Fig. 3
Mead

Mead

HD-64-237

Periodontia Instruments



Fig. 23
Seldin retractor

Seldin Retractor

HD-64-238

Periodontia Instruments

Periodontia Instruments



Williger
cm. 17

Williger

HD-64-239

Periodontia Instruments



Williger
cm. 16

Williger

HD-64-240

Periodontia Instruments



Williger
cm. 16

Williger

HD-64-241

Periodontia Instruments



Williger
cm. 13

Williger

HD-64-242

Periodontia Instruments



Fig. 1S/2S
Sugarman

Sugarman

HD-64-243

Periodontia Instruments



Fig. 3S/4S
Sugarman

Sugarman

HD-64-244

Periodontia Instruments

Periodontia Instruments



Fig. 1/2
TG Chisel

TG Chsel

HD-64-245

Periodontia Instruments



Fig. 1/2
TG Chisel

TG Chsel

HD-64-246

Periodontia Instruments



Fig. 1
TG Chisel

TG Chsel

HD-64-247

Periodontia Instruments



Fig. 2
TG Chisel

TG Chsel

HD-64-248

Periodontia Instruments



Fig. 1
(15K)
Kirkland

Kirkland

HD-64-249

Periodontia Instruments



Fig. 2
(16K)
Kirkland

Kirkland

HD-64-250

Periodontia Instruments

Periodontia Instruments



Fig. 1
Orban

Orban

HD-64-251

Periodontia Instruments



Fig. 2
Orban

Orban

HD-64-252

Periodontia Instruments



Plastic Filling #179

HD-64-257

Plastic Filling With Hollow Handle French Tips Blue Titanium Coated.



Sinus Lift Curettes

HD-64-258

Sinus Lift Curettes #4 Hollow Designed Blue Colored Handle.



Fig#17/18

Gracy Curettes #17/18

HD-64-259

Gracy Curettes Hollow Handle It's a French Tips with Black Titanium Coated.



Molt #9

Molt 9 Periosteal Elevator

HD-64-260

Molt #9 Periosteal Elevator Hollow Handle French Tips Fully Blue Titanium Coated.

Periodontia Instruments



Molt 8 Periosteal Elevator

HD-64-261

Molt #8 Periosteal Elevator Hollow Handle French Tips & Fully Blue Titanium Coated.



Band Pusher

HD-310-156

Band pusher with a hollow handle for easy handling to safely band setting.



Band Pusher Mershon

HD-64-253

Band Pusher Mershon French Tip



Band Pusher Scaler

HD-64-254

Band Pusher With Scaler Hollow Handle.



Band Pusher Elastic Remover

HD-64-255

Band Pusher With Elastic Remover Hollow.



Bite Stick High Heat

HD-64-256

Bite Stick . Available in Triangle and Round Tip. Autoclaveable Upto 135° C



Bite Stick

HD-64-262

Bite Stick . Available in Triangle and Round Tip. Autoclaveable Upto 135° C
These colors are available, Green,Red,Purple,White,Blue,Orange,Sky Blue,Grey and Yellow.

Filling instruments

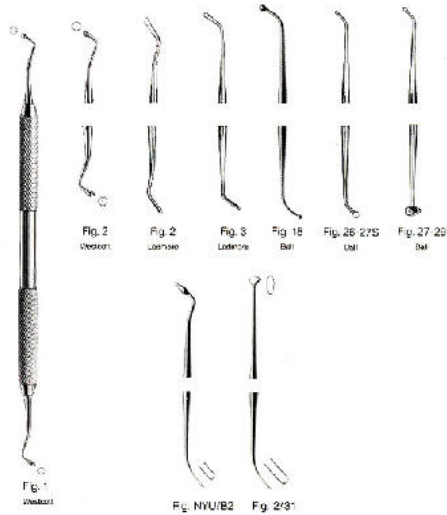

Westcott

HD-65-101

Filling instruments

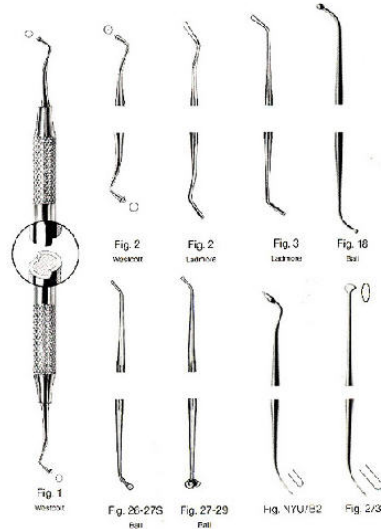

Westcott

HD-65-110

Filling instruments

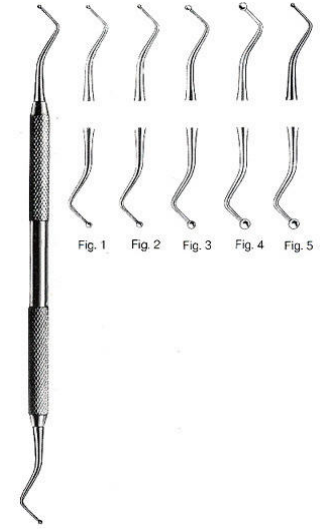

HD-65-119

Filling instruments

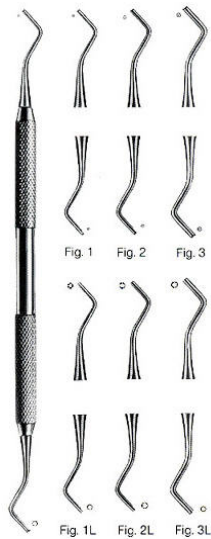

HD-65-125

Filling instruments



Plastic Filling

HD-65-126

Plastic Filling Solid Handle.

Cement Spatulas



Cement Spatulas

HD-66-101

No. 22 Cement Spatula



Cement Spatulas

HD-66-102

No. 24A Cement Spatula, Rigid



Cement Spatulas

HD-66-103

No. 24 Cement Spatula, Flexible



Cement Spatulas

HD-66-104

No. 313 Cement Spatula,



Cement Spatulas

HD-66-105

No. 5 Cement Spatula



Cement Spatulas

HD-66-106

No. 7 Cement Spatula

Single/Double End Explorers

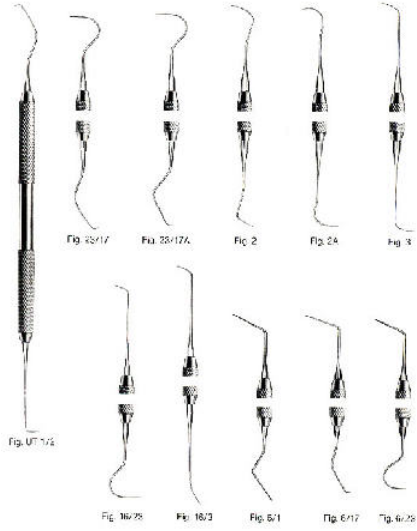

HD-67-101

Single Ended/ Double Ended Explorers

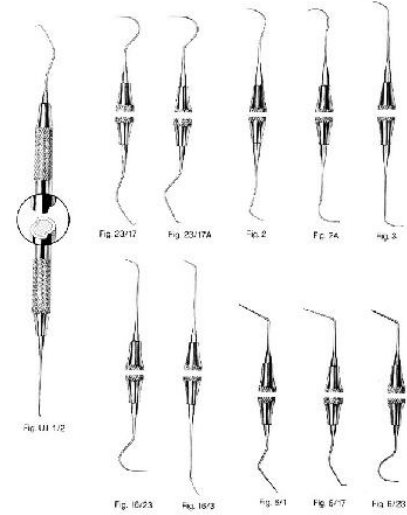

HD-67-112

Single Ended/ Double Ended Explorers



SIMPLE STEM PLANE 4

HD-68-113

MOUTH MIRROR



SIMPLE STEM PLANE 5

HD-68-114

MOUTH MIRROR



SIMPLE STEM PLANE 4

HD-68-115

MOUTH MIRROR



SIMPLE STEM PLANE 4

HD-68-116

MOUTH MIRROR



SIMPLE STEM PLANE 4

HD-68-117

MOUTH MIRROR



SECO / CONE-SOCKET

HD-68-118

Mirror Handles



OCTOGONAL CONE SOCKET

HD-68-119

Mirror Handles



MARTIN ERGO

HD-68-120

Mirror Handles



Mirror Handles

HD-68-121

Mirror Handles



Mirror Handles

HD-68-122

Mirror Handle



Mirror Handles

HD-68-123

Mirror Handles



Mirror Handles

HD-68-124

Mirror Handles



Laryngeal Mirrors

HD-68-128

MIRROR HANDLES



Laryngeal Mirrors

HD-68-129

MIRROR HANDLES



Cotton Wool Container

HD-68-130

Cotton Wool Container



Napkin Holder

HD-68-131

Napkin Holder



MIRROR HANDLE CONE SOCKET

HD-53-721-01

MIRROR HANDLES



MIRROR HANDLE CONE SOCKET

HD-53-721-02

MIRROR HANDLES



MIRROR HANDLE CONE SOCKET

HD-53-723-01

MIRROR HANDLES



MIRROR HANDLE

HD-53-728-02

MIRROR HANDLES



MARTIN-GRIP

HD-53-746-02



MIRROR HANDLE

HD-53-755-02

MIRROR HANDLES



MIRROR HANDLE

HD-53-757-08

MIRROR HANDLES



MIRROR

HD-53-702-22



MIRROR
HD-53-703-22



RHODIUM MIRROR
HD-53-704-10
MIRROR



RHODIUM MIRROR
HD-53-704-18
MIRROR



CONE SOCKET
HD-53-706-22
MIRROR



CONE SOCKET
HD-53-707-22
MIRROR



MICRO-MOUTH MIRROR
HD-53-710-03

Mirror Handles



MICRO-MOUTH MIRROR

HD-53-710-05

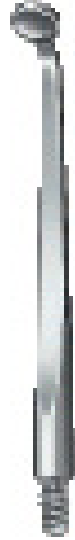

RHODIUM MICRO MIRROR

HD-53-711-03



HILGER

HD-53-715-00



HILGER

HD-53-715-01

CHEEK RETRACTORS



Mirror With Handle

HD-53-716

Simple Stem Plain Mirror Size # 5



Dental Patient Mirror With Handle

HD-53-717

Dental Patient Mirror With Handle for patient review. Available colors are ,Sky Blue, Green, Black, White, Pink and Orange.



Fig. 1
Spreader

Root Spreader Fig 1

HD-69-101

Endodontic Instruments



Fig. 2
Spreader

Root Spreader Fig 2

HD-69-102

Endodontic Instruments



Fig. 3
Spreader

Root Spreader Fig 3

HD-69-103

Endodontic Instruments



Fig. 4
Spreader

Root Spreader Fig 4

HD-69-104

Endodontic Instruments



Fig. 5
Spreader

Root Spreader Fig 5

HD-69-105

Endodontic Instruments



Fig. 6
Spreader

Root Spreader Fig 6

HD-69-106

Endodontic Instruments

Endodontic Instruments



Fig. 7
Spreader

Root Spreader Fig 7

HD-69-107

Endodontic Instruments



Fig. 1
Luks

Luks Fig 1

HD-69-108

Endodontic Instruments



Fig. 2

LUKS Fig 2

HD-69-109

Endodontic Instruments



Fig. 3

LUKS Fig 3

HD-69-110

Endodontic Instruments



Fig. 4

LUKS Fig 4

HD-69-111

Endodontic Instruments



Fig. 1

Vertical Condenser Fig 1

HD-69-112

Endodontic Instruments



Fig. 2

Vertical Condenser Fig 2

HD-69-113

Endodontic Instruments



Fig. 3

Vertical Condenser Fig 3

HD-69-114

Endodontic Instruments



Fig. 6/1

Root Canal Explorer Fig 6/1

HD-69-116

Endodontic Instruments



Fig. 6/17

Root Canal Explorer Fig 6/17

HD-69-117

Endodontic Instruments



Fig. 6/23

Root Canal Explorer Fig 6/23

HD-69-118

Endodontic Instruments



Fig. 31L

Root Canal Excavators Fig 31L

HD-69-119

Endodontic Instruments



Fig. 32L

Root Canal Excavators Fig 32L

HD-69-120

Endodontic Instruments



Fig. 33L

Root Canal Excavators Fig 33L

HD-69-121

Endodontic Instruments



Fig. 6/1

Root Canal Explorers Fig 6/1

HD-69-122

Endodontic Instruments



Fig. 6/17

Root Canal Explorers Fig 6/17

HD-69-123

Endodontic Instruments



Fig. 6/23

Root Canal Explorers Fig 6/23

HD-69-124

Endodontic Instruments



Fig. 31L

Root Canal Excavators Fig 31L

HD-69-125

Endodontic Instruments



Fig. 32L

Root Canal Excavators Fig 32L

HD-69-126

Endodontic Instruments



Fig. 33L

Root Canal Excavators Fig 33L

HD-69-127

Endodontic Instruments



Lange Probe

HD-69-131

Lange Probe For Bracket Openers.



Distal Wire Bender

HD-69-129

Distal wire bender used to bend round Niti and Stainless Steel wires distal to upper and lower Molars and Premolars.



Ligature Scaler

HD-69-130

Ligature Scaler

Ligature Director

HD-69-128

Double ended light weight ligature director. Handle Non-magnet and point french stainless steel.



Ligature Tucker

HD-69-132

Ligature Tucker one side straight and other is angled for tucking ends of steel ligatures. Works around and between any bracket style.



Ligature Tucker

HD-69-133

Ligature Tucker one side zigzag and other is angled for tucking ends of steel ligatures. Works around and between any bra

Separating Spatulas



Heidemann

HD-70-101

Separating Spatulas



Heidemann

HD-70-102

Separating Spatulas



Heidemann

HD-70-104

Separating Spatulas



Heidemann

HD-70-105

Separating Spatulas



Heidemann

HD-70-106

Separating Spatulas



Heidemann

HD-70-107

Separating Spatulas

Separating Spatulas



Heidemann
HD-70-108
Separating Spatulas



Heidemann
HD-70-109
Separating Spatulas



Heidemann
HD-70-110
Separating Spatulas



Heidemann
HD-70-111
Separating Spatulas



Heidemann
HD-70-112
Separating Spatulas



Fig. 0

Excavators Fig 0

HD-71-101

Excavators



Fig. 1

Excavators Fig 1

HD-71-102

Excavators



Fig. 2

Excavators Fig 2

HD-71-103

Excavators



Fig. 3

Excavators Fig 3

HD-71-104

Excavators



Fig. 4

Excavators Fig 4

HD-71-105

Excavators



Fig. 5

Excavators Fig 5

HD-71-106

Excavators



Fig 6

Excavators Fig 6

HD-71-107

Excavators



Fig. 0

Excavators Fig 0

HD-71-108

Excavators



Fig. 1

Excavators Fig 1

HD-71-109

Excavators



Fig. 2

Excavators Fig 2

HD-71-110

Excavators



Fig. 3

Excavators Fig 3

HD-71-111

Excavators



Fig. 4

Excavators Fig 4

HD-71-112

Excavators



Fig. 5

Excavators Fig 5

HD-71-113

Excavators



Fig. 6

Excavators Fig 6

HD-71-114

Excavators



Fig. 6

Excavators Fig 6

HD-71-115

Excavators



Fig. 14

Excavators Fig 14

HD-71-116

Excavators



Fig. 17

Excavators Fig 17

HD-71-117

Excavators



Fig. 17W

Excavators Fig 17W

HD-71-118

Excavators



Fig. 18

Excavators Fig 18

HD-71-119

Excavators



Fig. 18W
Oval spoon

Oval Spoon Fig 18W

HD-71-120

Excavators



Fig. 19

Excavators Fig 19

HD-71-121

Excavators



Fig. 19W
Oval spoon

Oval Spoon Fig 19W

HD-71-122

Excavators



Fig. 6

Excavators Fig 6

HD-71-123

Excavators



Fig. 14

Excavators Fig 14

HD-71-124

Excavators



Fig. 17

Excavators Fig 17

HD-71-125

Excavators



Fig. 17W
Oval spoon

Oval Spoon Fig 17W

HD-71-126

Excavators



Fig. 18W
Oval spoon

Oval Spoon 18W

HD-71-127

Excavators



Fig. 19

Excavators Fig 19

HD-71-129

Excavators



Fig. 19W
Oval spoon

Oval Spoon Fig 19W

HD-71-130

Excavators



Fig. 38/39

Excavators Fig 38/39

HD-71-131

Excavators



Fig. 63/64

Excavators Fig 63/64

HD-71-133

Excavators



Fig. 65/66

Excavators Fig 65/66

HD-71-134

Excavators



Fig. 31L

Excavators Fig 31L

HD-71-135

Excavators



Fig. 32L

Excavators Fig 32L

HD-71-136

Excavators



Cleoid / Discoid

HD-71-137

No. 3/6 Excavator, double end



Cleoid / Discoid

HD-71-138

No. 89/92 Carver - Discoid 1" Cleoid, octagonal handle



Fig. U15
Towner

Towner Fig U15

HD-72-104

Scalers



Fig. U15/33
Towner Jaquette

Towner Jaquette Fig- U15/33

HD-72-105

Scalers



Fig. U15/30
Towner Jaquette

Towner Jaquette Fig- 15/30

HD-72-106

Scalers



Fig H5/33

Fig- H5/33

HD-72-107

Scalers



Fig H6/H7

Fig- H6/H7

HD-72-108

Scalers



Fig. 1/2

Fig- 1/2

HD-72-109

Scalers



Fig. U15/33
Towner Jaquette

Towner Jaquette Fig- U15/33

HD-72-110

Scalers



Fig. J15/30
Towner Jaquette

Towner Jaquette Fig- U15/30

HD-72-111

Scalers



Fig. 1

Fig- 1

HD-72-112

Scalers

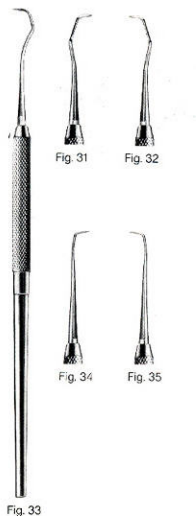

Fig. 33

HD-72-117

Scalers



Fig. H5
Hygienist

Hygienist Fig- H5

HD-72-122

Scalers



Aligner Removal Tool

HD-72-124

Aligner Removal in blue color.



Aligner Removal Tool

HD-72-123

Aligner Removal Hook stainless steel sterilizeable & autoclaveable.Total length is 3"



P.K. THOMAS CARVERS FIG. 1

HD-73-101

P.K.THOMAS WAX AND MODELLING CARVERS
FIG.1



P.K. THOMAS CARVERS FIG. 2

HD-73-102

P.K.THOMAS WAX AND MODELLING CARVERS
FIG.2



P.K. THOMAS CARVERS FIG. 3

HD-73-103

P.K.THOMAS WAX AND MODELLING CARVERS
FIG.3



P.K. THOMAS CARVERS FIG. 4

HD-73-104

P.K.THOMAS WAX AND MODELLING CARVERS
FIG.4



P.K. THOMAS CARVERS FIG. 5

HD-73-105

P.K.THOMAS WAX AND MODELLING CARVERS
FIG.5



P.K.THOMAS INSTRUMENTS

HD-73-106

P.K.THOMAS WAX AND MODELLING CARVERS
FIG.5 SILVER

Wax & Modelling Carvers



P.K.THOMAS INSTRUMENTS

HD-73-107

P.K.THOMAS WAX AND MODELLING CARVERS
FIG.4 RED



P.K.THOMAS INSTRUMENTS

HD-73-108

P.K.THOMAS WAX AND MODELLING CARVERS
FIG.3 BLUE



HD-73-111

FAHNENSTOCK Wax Carver 5 1/8" Knife, 5 1/8",
small



HD-73-112

FAHNENSTOCK Wax Carver 6 3/4" Knife, 6-
3/4", large



P.K.THOMAS INSTRUMENTS

HD-73-109

P.K.THOMAS WAX AND MODELLING CARVERS
FIG.2 GOLD



P.K.THOMAS INSTRUMENTS

HD-73-110

P.K.THOMAS WAX AND MODELLING CARVERS
FIG.1 GREEN



Impression Tray

HD-74-126

Impression Tray Perforated Extra Small lower.



Impression Trays

HD-74-127

Impression Tray Perforated With Rim Small Medium.



Impression Trays

HD-74-128

Impression Tray With Rim Perforated Medium Lower.



Impression Trays

HD-74-129

Impression Tray With Rim Perforated Large.



Impression Trays

HD-74-130

Impression Tray Perforated With Rim Extra Large Lower.



Impression Trays

HD-74-131

Impression Tray Perforated With Rim Small Medium Upper.



Impression Trays

HD-74-132

Impression Tray Perforated With Rim Medium Upper.



Impression Trays

HD-74-133

Impression Tray Perforated With Rim Large Upper.



Impression Trays

HD-74-134

Impression Tray Perforated With Rim Extra Large Upper.



Impression Trays

HD-74-135

Impression Tray Solid With Rim Extra Small Lower.

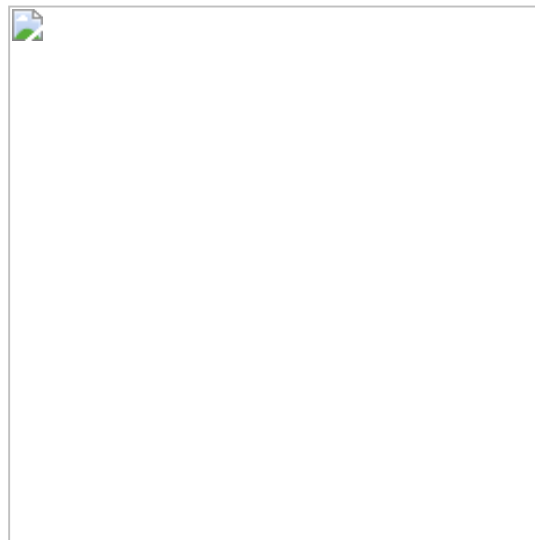

Impression Trays

HD-74-136

Impression Tray Full Arch Perforated Large Upper.

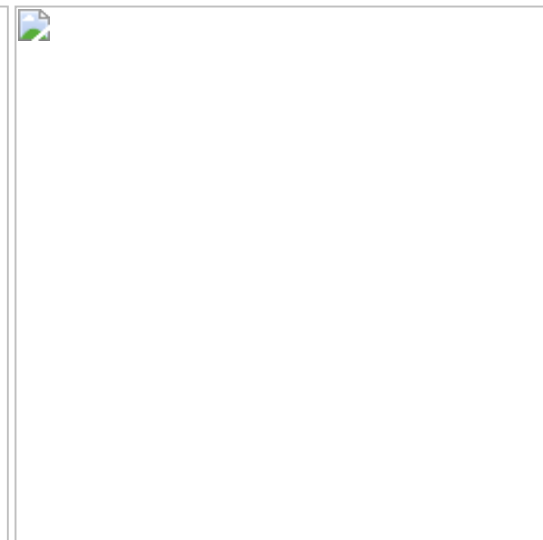

Impression Trays

HD-74-137

Impression Tray Full Arch Perforated Medium Upper.



HD-75-101
Dental Syringes



HD-75-102
Dental Syringes



Self Aspirating 1.8cc
HD-75-103
Dental Syringes



Cylinder Cartridge Syringe
HD-75-104
Dental Syringes



HD-75-105
Dental Syringes



Dental Syringes
HD-75-106
Dental Syringes



HD-75-107
Dental Syringes



C-W 1.8cc
HD-75-108
Dental Syringes



HD-75-109
Dental Syringes



HD-75-110
Dental Syringes



HD-75-111
Dental Syringes



HD-75-112
Dental Syringes

Dental Syringes



HD-75-113
Dental Syringes



Dental Syringes
HD-75-118
Dental Syringes



Dental Syringes
HD-75-119
Aspira-Plus



Dental Syringes
HD-75-120
Dental Syringes



Dental Syringes
HD-75-122
Dental Syringes



Dental Syringes
HD-75-124
Dental Syringes



Dental Syringes

HD-75-126

Dental Syringes



Dental Syringes

HD-75-127

Dental Syringes



Dental Syringe

HD-75-128

Aspira-Plus



Dental Syringe

HD-75-129



Dental Syringe

HD-75-130



Dental Syringe

HD-75-131



Dental Syringe

HD-75-132

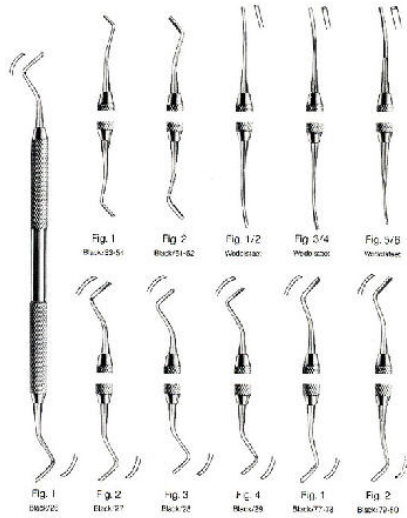

Wedeistaet
HD-76-101
Cavity Preparation

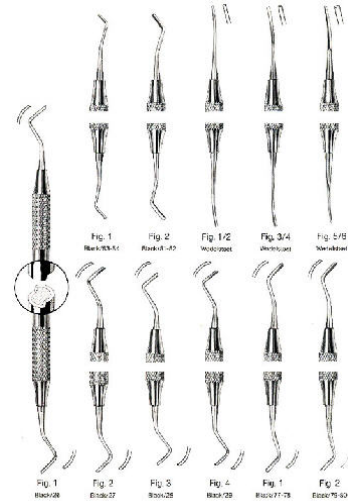

Wedeistaet
HD-76-112
Cavity Preparation



11 Briault D/E Explorer

HD-77-101

FIG. # 11 BRIAULT D/E EXPLORER. MADE OF SOLID STAINLESS STEEL HANDLE



11/12 Odu D/E Explorer

HD-77-102

FIG. # 11/12 OLD DOMINION UNIVERSITY D/E EXPLORER. MADE OF SOLID STAINLESS STEEL HANDLE



11/12 Odu D/E After Five Explorer

HD-77-103

FIG. # 11/12 ODU D/E AFTER FIVE EXPLORER. MADE OF SOLID STAINLESS STEEL HANDLE



2A Pigtail D/E Explorer

HD-77-104

FIG. # 2A PIGTAIL D/E EXPLORER. MADE OF SOLID STAINLESS STEEL HANDLE



2H D/E Explorer

HD-77-105

FIG. # 2H DE EXPLORER. MADE OF SOLID STAINLESS STEEL HANDLE



2R/2L D/E Explorer

HD-77-106

FIG. # 2R/2L D/E EXPLORER. MADE OF SOLID STAINLESS STEEL HANDLE



3 Pigtail D/E Explorer

HD-77-107

FIG. # 3 PIGTAIL D/E EXPLORER. MADE OF SOLID STAINLESS STEEL HANDLE



3CH Cowhorn D/E Explorer

HD-77-108

FIG. # 3CH COWHORN D/E EXPLORER. MADE OF SOLID STAINLESS STEEL HANDLE



3ES D/E Explorer

HD-77-109

FIG. # 3ES DE EXPLORER. MADE OF SOLID STAINLESS STEEL HANDLE



5 D/E Explorer

HD-77-110

FIG. # 5 D/E EXPLORER. MADE OF SOLID STAINLESS STEEL HANDLE



6/3 D/E Explorer

HD-77-111

FIG. # 6/3 DE EXPLORER. MADE OF SOLID STAINLESS STEEL HANDLE



17 S/E Explorer

HD-77-112

FIG. # 17 SE EXPLORER. MADE OF SOLID STAINLESS STEEL HANDLE



23 Shepherd's Hook Explorer

HD-77-113

FIG. # 23 SHEPHERD'S HOOK S/E EXPLORER.
MADE OF SOLID STAINLESS STEEL HANDLE



3 S/E Explorer

HD-77-114

FIG. # 3 SE EXPLORER. MADE OF SOLID
STAINLESS STEEL HANDLE



3A S/E Explorer

HD-77-115

FIG. # 3A S/E EXPLORER. MADE OF SOLID
STAINLESS STEEL HANDLE



54 S/E Explorer

HD-77-116

FIG. # 54 S/E EXPLORER. MADE OF SOLID
STAINLESS STEEL HANDLE



Explorer Classic

HD-77-117

Explorer Classic Single End



Explorer DipperE

HD-77-118

Explorer Dipper Single End



Short Probe

HD-77-119

Short Probe No.6 single ended.



HD-78-103

C tips for MORREL Crown Remover



HD-78-102

B tips for MORREL Crown Remover



HD-78-101

A tips for MORREL Crown Remover



HD-78-104

MORREL Crown Remover, with 3 points



HD-78-105

WYNMAN Carbide Crown Gripper, 5-1/2" ,
without ratchet, with TC jaws



X-Ray Film Hangers 6 Clips

HD-79-101

X-RAY FILM HANGERS 6 CLIPS MADE OF STAINLESS STEEL



X-Ray Film Hangers 10 Clips

HD-79-102

X-RAY FILM HANGERS 10 CLIPS MADE OF STAINLESS STEEL

Matrix Retainers



Matrix Retainer Toffilemire

HD-80-101

MATRIX BAND RETAINER TOFFILEMIRE.
AVAILABLE IN STRAIGHT & CONTRA. STAINLESS
STEEL



**Toffilemire Matrix Retainer Junior /
Child**

HD-80-102

MATRIX BAND RETAINER TOFFILEMIRE JUNIOR /
CHILD. AVAILABLE IN STRAIGHT & CONTRA.
STAINLESS STEEL



**Toffilemire Matrix Retainer Senior /
Adult**

HD-80-103

MATRIX BAND RETAINER TOFFILEMIRE SENIOR /
CHILD. AVAILABLE IN STRAIGHT & CONTRA.
STAINLESS STEEL



**Toffilemire Matrix Retainer
Universal**

HD-80-104

MATRIX BAND RETAINER TOFFILEMIRE
UNIVERSAL. AVAILABLE IN STRAIGHT & CONTRA.
STAINLESS STEEL



Matrix Band Retainer Ivory 8

HD-80-105

MATRIX BAND RETAINER IVORY 8, AVAILABE IN
5MM, 6MM, 7MM. STAINLESS STEEL



Matrix Band Retainer Ivory Plain

HD-80-106

MATRIX RETAINER IVORY PLAIN / WITHOUT
LATERAL SHIELD (JAW). STAINLESS STEEL

Matrix Retainers



Matrix Retainer Ivory With Shield

HD-80-107

MATRIX RETAINER IVORY WITH LATERAL SHIELD (JAW). STAINLESS STEEL



Matrix Retainer Cheek Protector

HD-80-108

MATRIX BAND RETAINER CHEEK PROTECTOR. STAINLESS STEEL



Matrix Band Retainer Nystrom Left

HD-80-109

MATRIX BAND RETAINER NYSTROM LEFT. STAINLESS STEEL



Matrix Band Retainer Nystrom Right

HD-80-110

MATRIX BAND RETAINER NYSTROM RIGHT. STAINLESS STEEL



Matrix Band Retainer Siqveland (Ash Narrow)

HD-80-111

MATRIX BAND RETAINER SIQVELAND (ASH NARROW). STAINLESS STEEL



Matrix Band Retainer Siqveland (Ash Wide)

HD-80-112

MATRIX BAND RETAINER SIQVELAND (ASH WIDE). STAINLESS STEEL



Matrix Band Retainer Ivory Didner (Adjustable)

HD-80-113

Matrix Band Retainer Ivory Didner (Adjustable)



Matrix Retainer Ivory Separator

HD-80-114

MATRIX BAND RETAINER IVORY SEPARATOR.
STAINLESS STEEL



Matrix Retainer Elliott Separator

HD-80-115

MATRIX RETAINER ELLIOTE SEPARATOR.
STAINLESS STEEL



Matrix Retainer Ivory 8 N

HD-80-116

MATRIX BAND RETAINER IVORY 8N. MADE OF
STAINLESS STEEL



Matrix Retainer Didner 8 P

HD-80-117

MATRIX BAND RETAINER IVORY 8P. MADE OF
STAINLESS STEEL



Matrix Retainer Mifam

HD-80-119

Matrix Retainer Mifam

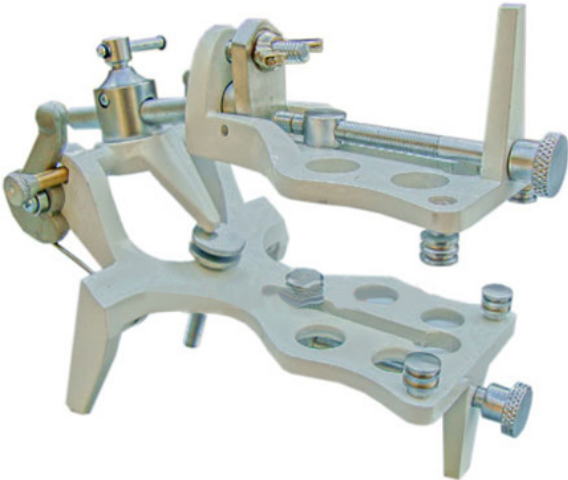

PLASTERLESS ARTICULATOR GALETTI (WHITE)

HD-81-101

HIGH TECH PLASTERLESS ARTICULATOR GALETTI WITH ADJUSTABLE SCREWS AT REARS & FRONT. SOLIDLY CONSTRUCTED OF METAL ALLOY CASTING. ALL ANATOMICAL MOVEMENTS POSSIBLE



Vibratory Polished Articulator Galetti

HD-81-102

GALETTI ARTICULATOR IS SOLIDLY CONSTRUCTED OF METAL ALLOY CASTING. EASY TO USE, ALLOWING QUICK FIXATION OF MODEL. IMMEDIATE ADJUSTMENT OF THE OCCLUSAL & CORRECTS IMULATION OF CENTRAL RELATION. ALL ANA



ANATOMICAL ARTICULATOR (ASA)

HD-81-103

ANATOMICAL ARTICULATOR WITH BEARING ROD & INCISIVE PIN, 4 MOUNTING PLATES & SUPPORTING BACK-PIN FOR 45° VIEW, OPENING 125°, INTERCONDYLAR DISTANCE 110 MM - SOLIDLY CONSTRUCTED OF METAL ALLOY CASTING



UNIVERSAL ARTICULATOR

HD-81-104

ANATOMICAL ARTICULATOR, MADE OF ALUMINUM PRESSOFUSION OF ONLY 590/GR OF WEIGHT. REALIZED FOR EASY VISIBILITY TO THE LINGUAL SURFACE & FOR A PERFECT STABILITY ALSO IN RESERVED POSITION. THE RETURN TO T



Gnatus Pro JP30 Articulator

HD-81-105

The Gnatus Pro JP30 Articulator offers the best performance with an excellent degree of accuracy. Its functionality makes easier both the procedures of taking and transferring the patient's reco



ANATOMICAL ARTICULATOR

HD-81-106

ANATOMICAL ARTICULATOR WITH INCISIVE PIN, 4 MOUNTING PLATES AND SUPPORTING BACK-PIN FOR 45° VIEW, OPENING 125°, INTERCONDYLAR DISTANCE 110 MM. - AVAILABLE IN ASSORTED COLOR



KEYSTONE BLACK ARTICULATOR WIRED

HD-81-107

KEYSTONE DELUXE UNIVERSAL TYPE-A ARTICULATOR. INTERCHANGEABLE, INCISAL PIN INCLUDED, LATERAL EXCURSIONS.



KEYSTONE DELUXE MAGNET ARTICULATOR

HD-81-108

KEYSTONE DELUXE MAGNETIC DENTURE ARTICULATOR WITH PLATES, INTERCHANGEABLE, INCISAL PIN INCLUDED. MAGNETIC SPLIT CASTING ENSURES EASY & EXACT SETTING, LATERAL EXCURSIONS

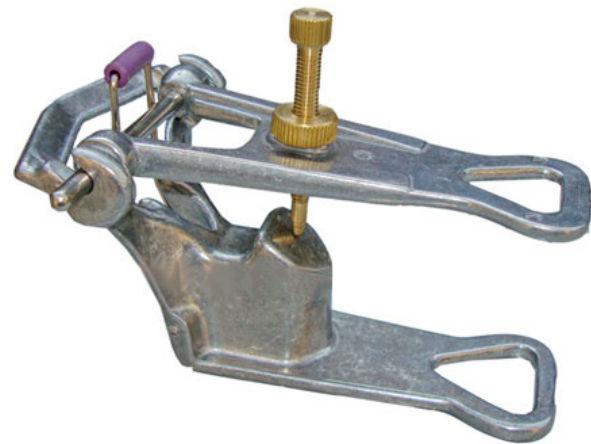

PROFESSIONAL OCCLUSOR ARTICULATOR

HD-81-109

PROFESSIONAL OCCLUSOR, VIBRATORY POLISHED ARTICULATOR - ALUMINUM, BRASS, STAINLESS STEEL



Magicart-1 Articulator

HD-81-110

LIGHTWEIGHT, HIGH-QUALITY MAGIC ART ARTICULATOR SECURELY HOLDS QUADRANT MODELS, CONSERVE MATERIALS & TIME! QUICKLY & EASILY MOUNT PRE-CAST DENTAL MODELS WITH THE HIGH QUALITY. WITH MAGICART, YOU C



FULL DENTURE ARTICULATOR (ROUND)

HD-81-111

FULL DENTURE CHROME PLATED ARTICULATOR (3 SLOT ROUND)

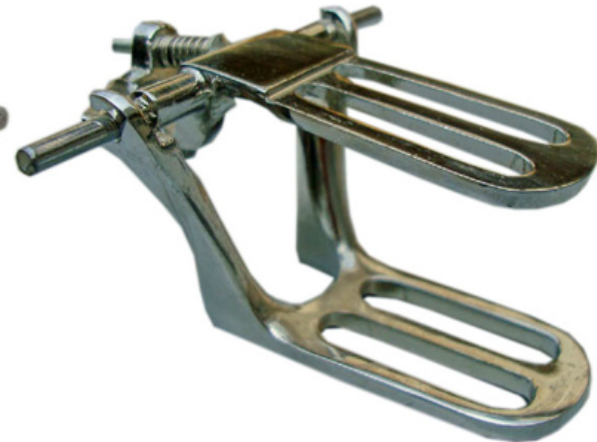

MODEL 'M' HI TOP STEPHAN ARTICULATOR

HD-81-112

FULL DENTURE CHROMIUM PLATED ARTICULATOR. PROVIDES ADDITIONAL VERTICAL DIMENSION FOR ACCEPTANCE OF HIGHER MODELS. 49 WIDE AT THE JOINT & HAS A VERTICAL SPAN BETWEEN PARALLEL BOWS OF 25/8"



Chromium Plated Plain Round

HD-81-113

Nickle Chromium Plated Plain Round Articulator



UNIVERSAL ARTICULATOR (YELLOW)

HD-81-114

UNIVERSAL ARTICULATOR OPENING 125° WITH 4 MOUNTING PLATES - CONDYLAR INCLINATION FIXED AT 30°, INTERCONDYLAR DISTANCE AT 110MM, BENNET ANGLE FIXED AT 7°, DISTANCE BETWEEN MOUNTING PLATES 85 MM. SOLIDLY



FOSTER DENTURE ARTICULATOR

HD-81-115

THIS ARTICULATOR IS EQUIPPED WITH AN ADJUSTABLE ANTERIOR PIN STOP & POSTERIOR SCREW STOP, AND CONSTRUCTED OF A SLIGHTLY HEAVIER GAUGE BRASS GIVING THE ARTICULATOR A MORE SOLID FEEL.



FORK CHROME PLATED ARTICULATOR

HD-81-116

NICKLE CHROMIUM PLATED ARTICULATOR FORK PATTERN



HINGE ARTICULATOR FULL ARCH

HD-81-117

AN ECONOMICAL & SIMPLE CHROMIUM PLATED HINGE ARTICULATOR FOR MOUNTING FULL ARCH CASES. LOW BACK



QUADRANT / CROWNED BRIDGE ARTICULATOR

HD-81-118

BRASS HINGE CROWNED BRIDGE ARTICULATOR FOR MOUNTING QUADRANT CASES. CROWN & BRIDGE ARTICULATOR IS POPULAR FOSTER # 57 DESIGN, ELIMINATES THE NEED TO BREAK OFF MODELS



UNIVERSAL ARTICULATOR (BLUE)

HD-81-119

UNIVERSAL ARTICULATOR OPENING 125° WITH 4 MOUNTING PLATES - CONDYLAR INCLINATION FIXED AT 30°, INTERCONDYLAR DISTANCE AT 110MM, BENNET ANGLE FIXED AT 7°, DISTANCE BETWEEN MOUNTING PLATES 85 MM. SOLIDLY



FOSTER / APEX # 2 ARTICULATOR

HD-81-120

FOSTER / APEX # 2 ARTICULATOR, THE WIDTH AT THE JOINT IS 1-3/4" WITH A VERTICAL PARALLEL HEIGHT OF 2-1/8". THE SMALL SIZE OF THIS ARTICULATOR ALLOWS THE VERSATILITY TO USE FOR FULL OR PARTIAL WORK. TH



Model "A" Crescent Stephan Articulator

HD-81-125

CRESCENT STEPHAN MODEL "A" ARTICULATOR IS USED FOR PARTIALS, CENTER SPRING WITH ADJUSTABLE TENSION, SMOOTH BRASS CASTINGS WITH NICKEL PLATING, CENTER BAR IN BOTH UPPER & LOWER BOW FOR MAXIMUM PLASTER



Bite Fork / Occlusal Alignment Plane

HD-81-126

BITE FORK IS A RELIABLE INSTRUMENT FOR CHECKING THE CORRECT POSITION OF THE MASTICATORY PLANE, ACHIEVING PARALLELISM OF THE OCCLUSAL PLANE WITH THE CAMPER'S LINE & THE BIPUPILLARY LINE IS FUNDAMENTAL

Miscellaneous Laboratory Instruments



HD-82-101

Bandage and Utility Scissors, 7-1/2" (19.1 cm), needle destroyer, serrated blade, autoclavable



HD-82-102

Plaster and Compound Knife



HD-82-103

Soldering Tweezers, curved



HD-82-104

SWISS Jeweler style Forceps, non-magnetic stainless steel, style 3, narrow, fine, 4-3/4" (12.1 cm)



HD-82-105

SWISS Jeweler style Forceps, non-magnetic stainless steel, style 5, Super fine, 4-3/8" (11.2 cm)



HD-82-106

SWISS Jeweler style Forceps, non-magnetic stainless steel, style 7, fine, curved, 4-1/2" (11.4 cm)

Miscellaneous Laboratory Instruments



Calipers

HD-82-107

Calipers



Calipers

HD-82-108

Calipers



Steel Ruler

HD-82-109

Steel Ruler



Forceps For Articulation Paper

HD-82-110

Forceps for articulation paper



Wide Throat Lens Caliper

HD-1035

Wide Throat Lens Caliper. Accommodates lens blanks of over 90mm diameter and 22mm in thickness. 1/10mm.



Spring Divider

HD-1034 D

Spring Divider leg length 3".



Boley Gauge

HD-1001

Boley gauge. Measures 0-10cm with mm markings.



Braunstein Fixed Caliper

HD-1017

Braunstein Fixed Caliper



Boley Gauge

HD-1003

Boley gauge. Measures 0-10cm with mm markings.



Special Vernier Calipers

HD-1004

Special Vernier Calipers For Dentists Purposes Made Of Stainless Steel. Measuring Range 80mm.



Bone Caliper Double Scale

HD-1005

Bone Caliper with double scale for mapping bone width. Measures 0-25mm range.



Bone Ridge Mapping Caliper

HD-1006

Caliper, Ridge Mapping Bone Width 0-25mm, both side reading.



Iwanson Caliper Metal & Wax

HD-1007

Iwanson Caliper Metal & Wax. Measuring range 10mm.

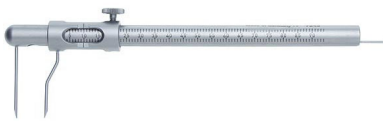

Implant Gauge

HD-1008

Facilitates Positioning Of Implants. Measures 0-100mm Range.



Bone Bracket Positioner Gauge

HD-1009

Bone Bracket Positioner Gauge 3.5 to 5.0mm



Swivel Bracket Height Gauge

HD-1010

Swivel Bracket Height Gauge, 3.5, 4.0, 4.5, 5.0mm Available in .018 or .022 versions. (45 Degree & 90 Degree)



Bracket Height Gauge

HD-1011

Incorporates a precision bar to seat in archwire slot at a 3.5, 4.0, 4.5 or 5mm distance from occlusal rest to accurately position brackets during bonding. Made of Stainless steel .018 versions.



Bracket Height Gauge 022

HD-1012

Incorporates a precision bar to seat in archwire slot at a 3.5, 4.0, 4.5 or 5mm distance from occlusal rest to accurately position brackets during bonding. Made of Stainless steel & aluminum



Bracket Height Gauge

HD-1013

Incorporates a precision bar to seat in archwire slot at a 5.5, 6.0, 6.5, 7.0mm distance from occlusal rest to accurately position brackets during bonding. Made of Stainless steel & aluminum availa



Finger Endo Roller

HD-1014

Finger Endo Roller.



Finger Endo Roller Adjustable

HD-1015

Finger endo ruler Adjustable stainless steel, millimeter scale.



Aluminum Bracket Height Gauge

HD-1016

Incorporates a precision bar to seat in arch wire slot at a 3.5, 4.0, 4.5 or 5mm distance from occlusal rest to accurately position brackets during bonding. Made of aluminum available in 018/022 versi



Deluxe Vernier Caliper

HD-1002

Deluxe Vernier Caliper 80mm.



Castroviejo Caliper

HD-1018

Castroviejo Caliper Straight Made of stainless steel and is used to measure bone or other oral structures. Measures Range 20mm.



Castroviejo Caliper Angled

HD-1019

Castroviejo Caliper Angled Made of stainless steel and is used to measure bone or other oral structures. Measures Range 20mm



Castroviejo Caliper

HD-1020



Castroviejo Caliper

HD-1021



Castroviejo Caliper

HD-1022

Castroviejo Caliper Long Beak Straight Made of stainless steel and is used to measure bone or other oral structures. Measures Range 40mm.



Castroviejo Caliper

HD-1023

Castroviejo Caliper Window Shape Made of stainless steel and is used to measure bone or other oral structures. Measures Range 40mm. Available in Straight and Angled.



Brass Gauge

HD-1024

Brass Gauge Measuring Range 80mm.



Spring Divider

HD-1025

Arm length 200 mm, Maximum opening of 215 mm



Divider

HD-1026

The Satin natural steel finish legs 3"



Spring Divider

HD-1027

The Satin natural steel finish legs 4"



Spring Divider

HD-1028

The Satin natural steel finish legs 8"



Spring Divider Outside

HD-1029

Spring Divider Outside 150mm



Spring Divider Inside

HD-1030

Spring Divider Inside 150mm



Spring Divider

HD-1031

Divider 150mm, maximum opening capacity 6"



Bite Gauge

HD-1036

Bite Gauge



Metal Ruler

HD-1037

Metal Ruler



Bracket Height Gauge Set

HD-1038

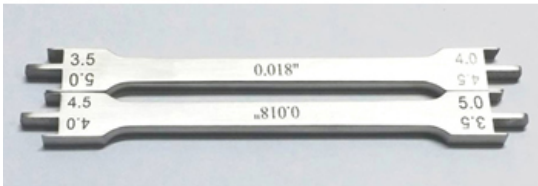

Bracket Height Gauge

HD-1039

Bracket Height Gauge 0.018



Bracket Height Gauge

HD-1040

Bracket Height Gauge 0.018



Bow Divider

HD-1041

Bow Divider stainless steel use for measuring distances between points, and scribing circles or arcs.



CONTACT US

Address: Mustafa Town,S.I.E
51310 Sialkot, Pakistan

Cell : +92-333-8774769

E-mail : info@hadidental.com

Phone : +92-52-3240111

Email : www.hadidental.com